



Republic of the Philippines
PHILIPPINE HEALTH INSURANCE CORPORATION
Olympic Centre Building, 109 Shaw Boulevard, Pasig City
Call Center: (02) 441-7447 TOLLFREE: (02) 441-7444
www.phichealth.gov.ph



BIDDING DOCUMENTS

for the

Procurement of Three (3) Lots
Leasehold Improvement

ITB NO. LI 2018-01-Infra



INVITATION TO BID
PROCUREMENT OF THREE (3) LOTS LEASEHOLD IMPROVEMENT
(ITB NO. LI 2018-01-INFRA)

1. The Philippine Health Insurance Corporation, through the Corporate Operating Budget for CY 2018 intends to apply the sum of *One Million Five Hundred Sixty Four Thousand Five Hundred Four Pesos (PhP1,564,504.00)* being the Approved Budget for the Contract (ABC) to payments under the contract for the *Procurement of Three (3) Lots Leasehold Improvement (ITB No. LI 2018-01-GS)*. Bids received in excess of the ABC shall be automatically rejected at bid opening.
2. The Philippine Health Insurance Corporation now invites bids on the *Bidding for the Procurement of Three (3) Lots Leasehold Improvement*. Completion of the Works is required within sixty (60) calendar days after issuance and receipt by the winning bidder of the Notice to Proceed. Bidders should have completed a contract similar to the Project. The description of an eligible bidder is contained in the Bidding Documents, particularly, in Section II. Instructions to Bidders.
3. Bidding will be conducted through open competitive bidding procedures using a non-discretionary "pass/fail" criterion as specified in the Revised Implementing Rules and Regulations (IRR) of Republic Act (RA) 9184, otherwise known as the "Government Procurement Reform Act".

Bidding is restricted to Filipino citizens/sole proprietorships, partnerships, or organizations with at least seventy-five percent (75%) interest or outstanding capital stock belonging to citizens of the Philippines, and to citizens or organizations of a country the laws or regulations of which grant similar rights or privileges to Filipino citizens, pursuant to RA 5183 and subject to Commonwealth Act 138.

4. Interested bidders may obtain further information from the PhilHealth-Bids and Awards Committee for Infrastructure Secretariat and inspect the Bidding Documents at the address given below during office hours from 8:30AM to 4:00PM.
5. A complete set of Bidding Documents may be acquired by interested Bidders starting on **January 9, 2019 (8:30AM - 4:00PM)** and on **January 29, 2019 (8:30AM - 10:30AM)** from the address below and upon payment of a non-refundable fee for the Bidding Documents, pursuant to the latest Guidelines issued by the GPPS, in the amount of **Five Thousand Pesos (PhP5,000.00)** only. It may also be downloaded free of charge from the website of the Philippine Government Electronic Procurement System (PhilGEPS) and the PhilHealth website, provided that Bidders shall pay the non-refundable fee for the Bidding Documents not later than the submission of their bids.
6. The BAC-GS will hold a Pre-Bid Conference on **January 17, 2019 10:30AM** at SBAC Conference Area (Room 1004), PhilHealth Head Office, 10th Floor Crystale Centre, 709 Shaw Blvd., Bgy. Oranjo, Pasig City which shall be open to prospective bidders.

7. Bids must be duly received by the BAC-GS Secretariat at the address below on or before **January 29, 2019, 10:30AM**. All Bids must be accompanied by a bid security in any of the acceptable forms and in the amount stated in Instruction to Bidders [ITB] Clause 18.

Bid opening shall be on **January 29, 2019, 10:30AM** at the SBAC Conference Area, (Rm. 1004), PhilHealth Head Office, 10th Flr., Citystate Centre Bldg. 709 Shaw Blvd., Brgy. Oranbo, Pasig City. Bids will be opened in the presence of the Bidders' representatives who choose to attend at the address below. Late bids shall not be accepted.

8. The bidder shall drop one (1) sealed master envelope in the bid box as specified in the Instruction to Bidder Clause 20 and Bid Data Sheet for Sealing and Markings of the envelopes.
9. The Philippine Health Insurance Corporation reserves the right to accept or reject any bid, to annul the bidding process, and to reject all bids at any time prior to contract award, without thereby incurring any liability to the affected bidder or bidders.
10. For further information, please refer to:
Secretariat for the Bids and Awards Committees
PhilHealth Head Office, Room 1003, 10th Floor, Citystate Centre Bldg.
709 Shaw Blvd., Brgy. Oranbo, Pasig City
Telephone Nos.: 441-7444 local 7675 / Telefax: 637-4135
maximol@philhealth.gov.ph / mascarenasn@philhealth.gov.ph

SVP/CIO JOVITA V. ARAGONA
Chairperson, BAC-INFRA

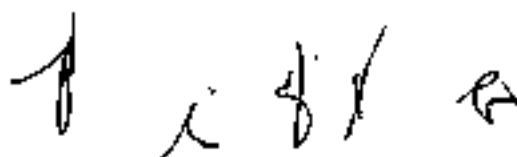

A. General

1. Scope of Bid

- 1.1. The Procuring Entity named in the **BDS**, invites bids for the construction of Works, as described in Section VI. Specifications.
- 1.2. The name, identification, and number of lots specific to this bidding are provided in the **BDS**. The contracting strategy and basis of evaluation of lots is described in **ITB** Clause 27.
- 1.3. The successful Bidder will be expected to complete the Works by the intended completion date specified in **SCC** Clause 1.17.

2. Source of Funds

The Procuring Entity has a budget or received funds from the Funding Source named in the **BDS**, and in the amount indicated in the **BDS**. It intends to apply part of the funds received for the Project, as defined in the **BDS**, to cover eligible payments under the Contract for the Works.

3. Corrupt, Fraudulent, Collusive, Coercive, and Obstructive Practices

3.1. Unless otherwise specified in the **BDS**, the Procuring Entity, as well as bidders and contractors, shall observe the highest standard of ethics during the procurement and execution of the contract. In pursuance of this policy, the Funding Source:

- (a) defines, for purposes of this provision, the terms set forth below as follows:
 - (i) "corrupt practice" means behavior on the part of officials in the public or private sectors by which they improperly and unlawfully enrich themselves, others, or induce others to do so, by misusing the position in which they are placed, and includes the offering, giving, receiving, or soliciting of anything of value to influence the action of any such official in the procurement process or in contract execution: entering, on behalf of the Procuring Entity, into any contract or transaction manifestly and grossly disadvantageous to the same, whether or not the public officer profited or will profit thereby, and similar acts as provided in Republic Act 3019;
 - (ii) "fraudulent practice" means a misrepresentation of facts in order to influence a procurement process or the execution of a contract to the detriment of the Procuring Entity, and includes collusive practices among Bidders (prior to or after Bid submission) designed to establish bid prices at artificial, non-competitive levels and to deprive the Procuring Entity of the benefits of free and open competition;

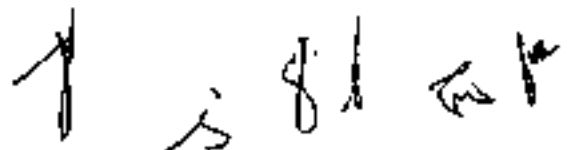

- (ii) "collusive practices" means a scheme or arrangement between two or more Bidders, with or without the knowledge of the Procuring Entity, designed to establish bid prices at artificial, non-competitive levels; and
 - (iv) "coercive practices" means harming or threatening to harm, directly or indirectly, persons, or their property to influence their participation in a procurement process, or affect the execution of a contract;
 - (v) "obstructive practice" is
 - (aa) deliberately destroying, falsifying, altering or concealing of evidence material to an administrative proceedings or investigation or making false statements to investigators in order to materially impede an administrative proceedings or investigation of the Procuring Entity or any foreign government/foreign or international financing institution into allegations of a corrupt, fraudulent, coercive or collusive practice; and/or threatening, harassing or intimidating any party to prevent it from disclosing its knowledge of matters relevant to the administrative proceedings or investigation or from pursuing such proceedings or investigation; or
 - (bb) acts intended to materially impede the exercise of the inspection and audit rights of the Procuring Entity or any foreign government/foreign or international financing institution herein.
 - (b) will reject a proposal for award if it determines that the Bidder recommended for award has engaged in corrupt or fraudulent practices in competing for the Contract; and
 - (c) will declare a firm ineligible, either indefinitely or for a stated period of time, to be awarded Contract funded by the Funding Source if it at any time determines that the firm has engaged in corrupt or fraudulent practices in competing for, or in executing, a Contract funded by the Funding Source.
- 3.2. Further, the Procuring Entity will seek to impose the maximum civil, administrative, and/or criminal penalties available under the applicable laws on individuals and organizations deemed to be involved in any of the practices mentioned in ITB Clause 3.1(a).
- 3.3. Furthermore, the Funding Source and the Procuring Entity reserve the right to inspect and audit records and accounts of a contractor in the bidding for and performance of a contract themselves or through independent auditors as reflected in the GCC Clause 34.

4. Conflict of Interest

4.1. All Bidders found to have conflicting interests shall be disqualified to participate in the procurement at hand, without prejudice to the imposition of appropriate administrative, civil, and criminal sanctions. A Bidder may be considered to have conflicting interests with another Bidder in any of the events described in paragraphs (a) through (c) and a general conflict of interest in any of the circumstances set out in paragraphs (d) through (g) below:

- (a) A Bidder has controlling shareholders in common with another Bidder;
- (b) A Bidder receives or has received any direct or indirect subsidy from any other Bidder;
- (c) A Bidder has the same legal representative as that of another Bidder for purposes of this Bid;
- (d) A Bidder has a relationship, directly or through third parties, that puts them in a position to have access to information about or influence on the bid of another Bidder or influence the decisions of the Procuring Entity regarding this bidding process;
- (e) A Bidder submits more than one bid in this bidding process. However, this does not limit the participation of subcontractors in more than one bid;
- (f) A Bidder who participated as a consultant in the preparation of the design or technical specifications of the goods and related services that are the subject of the bid; or
- (g) A Bidder who lends, or temporarily seconds, its personnel to firms or organizations which are engaged in consulting services for the preparation related to procurement for or implementation of the project, if the personnel would be involved in any capacity on the same project.

4.2. In accordance with Section 47 of the IRR of RA 9184, all Bidding Documents shall be accompanied by a sworn affidavit of the Bidder that it is not related to the Head of the Procuring Entity (HoPE), members of the Bids and Awards Committee (BAC), members of the Technical Working Group (TWG), members of the BAC Secretariat, the head of the Project Management Office (PMO) or the end-user unit, and the project consultants, by consanguinity or affinity up to the third civil degree. On the part of the Bidder, this Clause shall apply to the following persons:

- (a) If the Bidder is an individual or a sole proprietorship, to the Bidder himself;
- (b) If the Bidder is a partnership, to all its officers and members;

Handwritten signature and initials in black ink, appearing to be 'T. S. G. R. M.' with a large flourish at the end.

- (c) If the Bidder is a corporation, to all its officers, directors, and controlling stockholders;
- (d) If the Bidder is a cooperative, to all its officers, directors, and controlling shareholders or members; and
- (e) If the Bidder is a joint venture (JV), the provisions of items (a), (b), (c) or (d) of this Clause shall correspondingly apply to each of the members of the said JV, as may be appropriate.

Relationship of the nature described above or failure to comply with this Clause will result in the automatic disqualification of a Bidder.

5. Eligible Bidders

5.1. Unless otherwise indicated in the **BDS**, the following persons shall be eligible to participate in this Bidding:

- (a) Duly licensed Filipino citizens/sole proprietorships;
- (b) Partnerships duly organized under the laws of the Philippines and of which at least seventy five percent (75%) of the interest belongs to citizens of the Philippines;
- (c) Corporations duly organized under the laws of the Philippines, and of which at least seventy five percent (75%) of the outstanding capital stock belongs to citizens of the Philippines;
- (d) Cooperatives duly organized under the laws of the Philippines.
- (e) Persons/entities forming themselves into a JV, i.e., a group of two (2) or more persons/entities that intend to be jointly and severally responsible or liable for a particular contract: Provided, however, that, in accordance with Letter of Instructions No. 630, Filipino ownership or interest of the joint venture concerned shall be at least seventy five percent (75%); Provided, further, that joint ventures in which Filipino ownership or interest is less than seventy five percent (75%) may be eligible where the structures to be built require the application of techniques and/or technologies which are not adequately possessed by a person/entity meeting the seventy five percent (75%) Filipino ownership requirement: Provided, finally, that in the latter case, Filipino ownership or interest shall not be less than twenty five percent (25%). For this purpose, Filipino ownership or interest shall be based on the contributions of each of the members of the joint venture as specified in their JVA.

5.2. The Procuring Entity may also invite foreign bidders when provided for under any Treaty or International or Executive Agreement as specified in the **BDS**.

5.3. Government owned or controlled corporations (GOCCs) may be eligible to participate only if they can establish that they (a) are legally and financially

autonomous, (b) operate under commercial law, and (c) are not attached agencies of the Procuring Entity.

- 5.4. (a) The Bidder must have an experience of having completed a Single Largest Completed Contract (SLCC) that is similar to this Project, equivalent to at least fifty percent (50%) of the ABC adjusted, if necessary, by the Bidder to current prices using the Philippine Statistics Authority (PSA) consumer price index. However, contractors under Small A and Small B categories without similar experience on the contract to be bid may be allowed to bid if the cost of such contract is not more than the Allowable Range of Contract Cost (ARCC) of their registration based on the guidelines as prescribed by the PCAB.

(b) For Foreign-funded Procurement, the Procuring Entity and the foreign government/foreign or international financing institution may agree on another track record requirement, as specified in the **BDS**.

For this purpose, contracts similar to the Project shall be those described in the **BDS**.

- 5.5. The Bidder must submit a computation of its Net Financial Contracting Capacity (NFCC), which must be at least equal to the ABC to be bid, calculated as follows:

$$NFCC = [(Current\ assets\ minus\ current\ liabilities)\ (15)]\ minus\ the\ value\ of\ all\ outstanding\ or\ uncompleted\ portions\ of\ the\ projects\ under\ ongoing\ contracts,\ including\ awarded\ contracts\ yet\ to\ be\ started\ coinciding\ with\ the\ contract\ for\ this\ Project.$$

The values of the domestic bidder's current assets and current liabilities shall be based on the latest Audited Financial Statements (AFS) submitted to the BIR.

For purposes of computing the foreign bidders' NFCC, the value of the current assets and current liabilities shall be based on their audited financial statements prepared in accordance with international financial reporting standards.

6. Bidder's Responsibilities

- 6.1 The Bidder or its duly authorized representative shall submit a sworn statement in the form prescribed in:

- 6.2 Section IX Bidding Forms as required in ITB Clause 12.1 (b)(iii)

6.8. The Bidder is responsible for the following:

- (a) Having taken steps to carefully examine all of the Bidding Documents;
- (b) Having acknowledged all conditions, local or otherwise, affecting the implementation of the contract;
- (c) Having made an estimate of the facilities available and needed for the contract to be bid, if any;
- (d) Having complied with its responsibility to inquire or secure Supplemental/Bid Bulletin/s as provided under ITB Clause 10.4.
- (e) Ensuring that it is not "blacklisted" or barred from bidding by the GoP or any of its agencies, offices, corporations, or I.GUs, including foreign government/foreign or international financing institution whose blacklisting rules have been recognized by the GPPB;
- (f) Ensuring that each of the documents submitted in satisfaction of the bidding requirements is an authentic copy of the original, complete, and all statements and information provided therein are true and correct;
- (g) Authorizing the HoPE or its duly authorized representative/s to verify all the documents submitted;
- (h) Ensuring that the signatory is the duly authorized representative of the Bidder, and granted full power and authority to do, execute and perform any and all acts necessary to participate, submit the bid, and to sign and execute the ensuing contract, accompanied by the duly notarized Special Power of Attorney, Board/Partnership Resolution, or Secretary's Certificate, whichever is applicable;
- (i) Complying with the disclosure provision under Section 47 of RA 9184 and its IRR in relation to other provisions of RA 3019;
- (j) Complying with existing labor laws and standards, in the case of procurement of services. Moreover, bidder undertakes to:
 - (i) Ensure the entitlement of workers to wages, hours of work, safety and health and other prevailing conditions of work as established by national laws, rules and regulations; or collective bargaining agreement, or arbitration award, if and when applicable.

In case there is a finding by the Procuring Entity or the DOLE of underpayment or non-payment of workers' wage and wage-related benefits, bidder agrees that the performance security or portion of the contract amount shall be withheld in favor of the complaining workers pursuant to appropriate provisions of Republic Act No. 9184 without prejudice to the institution of

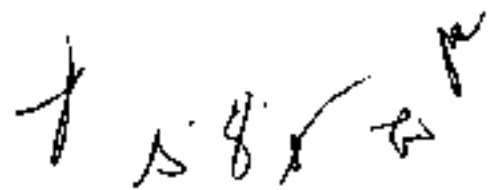

appropriate actions under the Labor Code, as amended, and other social legislations.

- (ii) Comply with occupational safety and health standards and to correct deficiencies, if any.

In case of imminent danger, injury or death of the worker, bidder undertakes to suspend contract implementation pending clearance to proceed from the DOLE Regional Office and to comply with Work Stoppage Order; and

- iii) Inform the workers of their conditions of work, labor clauses under the contract specifying wages, hours of work and other benefits under prevailing national laws, rules and regulations; or collective bargaining agreement; or arbitration award, if and when applicable, through posting in two (2) conspicuous places in the establishment's premises; and

- (k) Ensuring that it did not give or pay, directly or indirectly, any commission, amount, fee, or any form of consideration, pecuniary or otherwise, to any person or official, personnel or representative of the;

Failure to observe any of the above responsibilities shall be at the risk of the Bidder concerned.

6.9. The Bidder, by the act of submitting its bid, shall be deemed to have inspected the site, determined the general characteristics of the contract works and the conditions for this Project and examine all instructions, forms, terms, and project requirements in the Bidding Documents.

6.10. It shall be the sole responsibility of the prospective bidder to determine and to satisfy itself by such means as it considers necessary or desirable as to all matters pertaining to this Project, including: (a) the location and the nature of the contract, project, or work; (b) climatic conditions; (c) transportation facilities; (d) nature and condition of the terrain, geological conditions at the site communication facilities, requirements, location and availability of construction aggregates and other materials, labor, water, electric power and access roads; and (d) other factors that may affect the cost, duration and execution or implementation of the contract, project, or work.

6.11. The Procuring Entity shall not assume any responsibility regarding erroneous interpretations or conclusions by the prospective or eligible bidder out of the data furnished by the procuring entity. However, the Procuring Entity shall ensure that all information in the Bidding Documents, including supplemental/bid bulletins issued are correct and consistent.

6.12. Before submitting their bids, the Bidders are deemed to have become familiar with all existing laws, decrees, ordinances, acts and regulations of the Philippines which may affect the contract in any way.



- 6.13. The Bidder shall bear all costs associated with the preparation and submission of his bid, and the Procuring Entity will in no case be responsible or liable for those costs, regardless of the conduct or outcome of the bidding process.
- 6.14. The Bidder should note that the Procuring Entity will accept bids only from those that have paid the applicable fee for the Bidding Documents at the office indicated in the Invitation to Bid.

7. Origin of Goods and Services

There is no restriction on the origin of Goods, or Contracting of Works or Services other than those prohibited by a decision of the United Nations Security Council taken under Chapter VII of the Charter of the United Nations.

8. Subcontracts

- 8.1. Unless otherwise specified in the **BDS**, the Bidder may subcontract portions of the Works to an extent as may be approved by the Procuring Entity and stated in the **BDS**. However, subcontracting of any portion shall not relieve the Bidder from any liability or obligation that may arise from the contract for this Project.
- 8.2. Subcontractors must submit the documentary requirements under ITB Clause 12 and comply with the eligibility criteria specified in the **BDS**. In the event that any subcontractor is found by the Procuring Entity to be ineligible, the subcontracting of such portion of the Works shall be disallowed.
- 8.3. The Bidder may identify the subcontractor to whom a portion of the Works will be subcontracted at any stage of the bidding process or during contract implementation. If the Bidder opts to disclose the name of the subcontractor during bid submission, the Bidder shall include the required documents as part of the technical component of its bid.

B. Contents of Bidding Documents

9. Pre-Bid Conference

- 9.1. (a) If so specified in the **BDS**, a pre-bid conference shall be held at the venue and on the date indicated therein, to clarify and address the Bidders' questions on the technical and financial components of this Project.
- (b) The pre-bid conference shall be held at least twelve (12) calendar days before the deadline for the submission of and receipt of bids, but not earlier than seven (7) calendar days from the posting of the Invitation to Bid/Bidding Documents in the **PHIGEPS** website. If the Procuring Entity determines that, by reason of the method, nature, or complexity of the contract to be bid, or when international participation will be more advantageous to the GoP, a longer period for the preparation of bids is necessary, the pre-bid conference shall be held at least thirty (30) calendar days before the deadline for the submission and receipt of bids, as specified in the **BDS**.

[Handwritten signature]

- 9.2. Bidders are encouraged to attend the pre-bid conference to ensure that they fully understand the Procuring Entity's requirements. Non-attendance of the Bidder will in no way prejudice its bid; however, the Bidder is expected to know the changes and/or amendments to the Bidding Documents as recorded in the minutes of the pre-bid conference and the Supplemental/Bid Bulletin. The minutes of the pre-bid conference shall be recorded and prepared not later than five (5) calendar days after the pre-bid conference. The minutes shall be made available to prospective bidders not later than five (5) days upon written request.
- 9.3. Decisions of the BAC amending any provision of the bidding documents shall be issued in writing through a Supplemental/Bid Bulletin at least seven (7) calendar days before the deadline for the submission and receipt of bids.

10. Clarification and Amendment of Bidding Documents

- 10.1. Prospective bidders may request for clarification(s) on and/or interpretation of any part of the Bidding Documents. Such a request must be in writing and submitted to the Procuring Entity at the address indicated in the BDS at least ten (10) calendar days before the deadline set for the submission and receipt of Bids.
- 10.2. The BAC shall respond to the said request by issuing a Supplemental/Bid Bulletin, to be made available to all those who have properly secured the Bidding Documents, at least seven (7) calendar days before the deadline for the submission and receipt of Bids.
- 10.3. Supplemental/Bid Bulletins may also be issued upon the Procuring Entity's initiative for purposes of clarifying or modifying any provision of the Bidding Documents not later than seven (7) calendar days before the deadline for the submission and receipt of Bids. Any modification to the Bidding Documents shall be identified as an amendment.
- 10.4. Any Supplemental/Bid Bulletin issued by the BAC shall also be posted in the PhilGIPS and the website of the Procuring Entity concerned, if available, and at any conspicuous place in the premises of the Procuring Entity concerned. It shall be the responsibility of all Bidders who have properly secured the Bidding Documents to inquire and secure Supplemental/Bid Bulletins that may be issued by the BAC. However, Bidders who have submitted bids before the issuance of the Supplemental/Bid Bulletin must be informed and allowed to modify or withdraw their bids in accordance with ITB Clause 23.

C. Preparation of Bids

11. Language of Bids

The eligibility requirements or statements, the bids, and all other documents to be submitted to the BAC must be in English. If the eligibility requirements or statements, the bids, and all other documents submitted to the BAC are in foreign language other

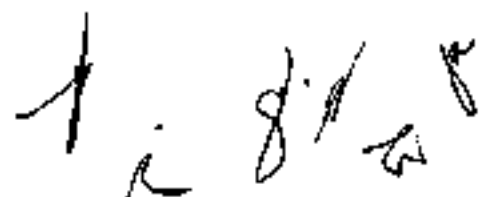

than English, it must be accompanied by a translation of the documents in English. The documents shall be translated by the relevant foreign government agency, the foreign government agency authorized to translate documents, or a registered translator in the foreign bidder's country; and shall be authenticated by the appropriate Philippine foreign service establishment/post or the equivalent office having jurisdiction over the foreign bidder's affairs in the Philippines. The English translation shall govern, for purposes of interpretation of the bid.

12. Documents Comprising the Bid: Eligibility and Technical Components

12.1. Unless otherwise indicated in the **BDS**, the first envelope shall contain the following eligibility and technical documents:

(a) Eligibility Documents -

Class "A" Documents

- (i) PhilGEPS Certificate of Registration and Membership in accordance with Section 8.5.2 of the IRR;
- (ii) Statement of all its ongoing government and private contracts, including contracts awarded but not yet started, if any, whether similar or not similar in nature and complexity to the contract to be bid; and

Statement of the Bidder's SLOC similar to the contract to be bid, in accordance with ITB Clause 5.4.

The two statements required shall indicate for each contract the following:

- (ii.1) name of the contract;
- (ii.2) date of the contract;
- (ii.3) contract duration;
- (ii.4) owner's name and address;
- (ii.5) nature of work;
- (ii.6) contractor's role (whether sole contractor, subcontractor, or partner in a JV) and percentage of participation;
- (ii.7) total contract value at award;
- (ii.8) date of completion or estimated completion time;
- (ii.9) total contract value at completion, if applicable;

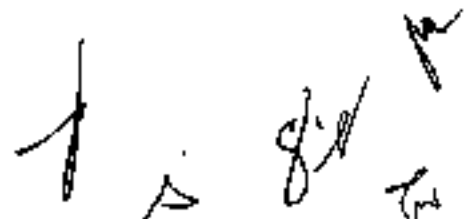

(ii.10) percentages of planned and actual accomplishments, if applicable; and

(ii.11) value of outstanding works, if applicable.

The statement of the Bidder's SLCC shall be supported by the Notice of Award and/or Notice to Proceed, Project Owner's Certificate of Final Acceptance issued by the Owner other than the Contractor or the Constructors Performance Evaluation System (CPES) Final Rating, which must be at least satisfactory. In case of contracts with the private sector, an equivalent document shall be submitted;

(iii) Unless otherwise provided in the **BDS**, a valid special PCAB License in case of joint ventures, and registration for the type and cost of the contract for this Project; and

(iv) NFCC computation in accordance with ITB Clause 5.5.

Class "B" Documents

(v) If applicable, Joint Venture Agreement (JVA) in accordance with RA 4566.

(b) Technical Documents –

(i) Bid security in accordance with ITB Clause 18. If the Bidder opts to submit the bid security in the form of:

(i.1) a bank draft/guarantee or an irrevocable letter of credit issued by a foreign bank, it shall be accompanied by a confirmation from a Universal or Commercial Bank; or

(i.2) a surety bond accompanied by a certification coming from the Insurance Commission that the surety or insurance company is authorized to issue such instruments.

(ii) Project Requirements, which shall include the following:

(ii.1) Organizational chart for the contract to be bid;

(ii.2) List of contractor's personnel (e.g., Project Manager, Project Engineers, Materials Engineers, and Foremen), to be assigned to the contract to be bid, with their complete qualification and experience data. These personnel must meet the required minimum years of experience set in the **BDS**; and

(ii.3) List of contractor's major equipment units, which are owned, leased, and/or under purchase agreements, supported by proof of ownership, certification of

availability of equipment from the equipment lessor/vendor for the duration of the project, as the case may be, which must meet the minimum requirements for the contract set in the BDS; and

- (ii) Sworn statement in accordance with Section 25.3 of the IRR of RA 9184 and using the form prescribed in
- (iv)
- (v)
- (vi)
- (vii)
- (viii)
- (ix) Section IX. Bidding Forms.

13. Documents Comprising the Bid: Financial Component

13.1. The financial component of the bid shall contain the following:

- (a) Financial Bid Form, which includes bid prices and the bill of quantities, in accordance with ITB Clauses 15.1 and 15.3; and
- (b) Any other document related to the financial component of the bid as stated in the BDS.

13.2. (a) Unless otherwise stated in the BDS, all Bids that exceed the ABC shall not be accepted.

- (b) Unless otherwise indicated in the BDS, for foreign-funded procurement, a ceiling may be applied to bid prices provided the following conditions are met:

- (i) Bidding Documents are obtainable free of charge on a freely accessible website. If payment of Bidding Documents is required by the procuring entity, payment could be made upon the submission of bids.
- (ii) The procuring entity has procedures in place to ensure that the ABC is based on recent estimates made by the engineer or the responsible unit of the procuring entity and that the estimates are based on adequate detailed engineering (in the case of infrastructure projects) and reflect the quality, supervision and risk and inflationary factors, as well as prevailing market prices associated with the types of works or goods to be procured.
- (iii) The procuring entity has trained cost estimators on estimating prices and analyzing bid variances. In the case of infrastructure projects, the procuring entity must also have trained quantity surveyors.

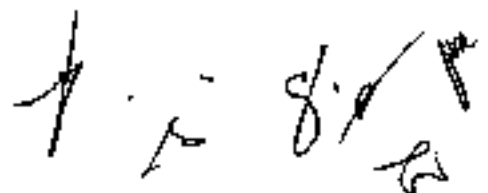

- (iv) The procuring entity has established a system to monitor and report bid prices relative to ABC and engineer's/procuring entity's estimate.
- (v) The procuring entity has established a monitoring and evaluation system for contract implementation to provide a feedback on actual total costs of goods and works.

14. Alternative Bids

- 14.1. Alternative Bids shall be rejected. For this purpose, alternative bid is an offer made by a Bidder in addition or as a substitute to its original bid which may be included as part of its original bid or submitted separately therewith for purposes of bidding. A bid with options is considered an alternative bid regardless of whether said bid proposal is contained in a single envelope or submitted in two (2) or more separate bid envelopes.
- 14.2. Bidders shall submit offers that comply with the requirements of the Bidding Documents, including the basic technical design as indicated in the drawings and specifications. Unless there is a value engineering clause in the BBS, alternative bids shall not be accepted.
- 14.3. Each Bidder shall submit only one Bid, either individually or as a partner in a JV. A Bidder who submits or participates in more than one bid (other than as a subcontractor if a subcontractor is permitted to participate in more than one bid) will cause all the proposals with the Bidder's participation to be disqualified. This shall be without prejudice to any applicable criminal, civil and administrative penalties that may be imposed upon the persons and entities concerned.

15. Bid Prices

- 15.1. The contract shall be for the whole Works, as described in ITB Clause 1.1, based on the priced Bill of Quantities submitted by the Bidder.
- 15.2. The Bidder shall fill in rates and prices for all items of the Works described in the Bill of Quantities. Bids not addressing or providing all of the required items in the Bidding Documents including, where applicable, Bill of Quantities, shall be considered non-responsive and, thus, automatically disqualified. In this regard, where a required item is provided, but no price is indicated, the same shall be considered as non-responsive, but specifying a zero (0) or a dash (-) for the said item would mean that it is being offered for free to the Government, except those required by law or regulations to be provided for.
- 15.3. All duties, taxes, and other levies payable by the Contractor under the Contract, or for any other cause, prior to the deadline for submission of bids, shall be included in the rates, prices, and total bid price submitted by the Bidder.
- 15.4. All bid prices for the given scope of work in the contract as awarded shall be considered as fixed prices, and therefore not subject to price escalation during



contract implementation, except under extraordinary circumstances as specified in GCC Clause 48. Upon the recommendation of the Procuring Entity, price escalation may be allowed in extraordinary circumstances as may be determined by the National Economic and Development Authority in accordance with the Civil Code of the Philippines, and upon approval by the GPPB. Furthermore, in cases where the cost of the awarded contract is affected by any applicable new laws, ordinances, regulations, or other acts of the GoP, promulgated after the date of bid opening, a contract price adjustment shall be made or appropriate relief shall be applied on a no loss-no gain basis.

16. Bid Currencies

- 16.1. All bid prices shall be quoted in Philippine Pesos unless otherwise provided in the BDS. However, for purposes of bid evaluation, bids denominated in foreign currencies shall be converted to Philippine currency based on the exchange rate prevailing on the day of the Bid Opening.
- 16.2. If so allowed in accordance with ITB Clause 16.1, the Procuring Entity for purposes of bid evaluation and comparing the bid prices will convert the amounts in various currencies in which the bid price is expressed to Philippine Pesos at the exchange rate as published in the *Bangko Sentral ng Pilipinas* (BSP) reference rate bulletin on the day of the bid opening.
- 16.3. Unless otherwise specified in the BDS, payment of the contract price shall be made in Philippine Pesos.

17. Bid Validity

- 17.1. Bids shall remain valid for the period specified in the BDS which shall not exceed one hundred twenty (120) calendar days from the date of the opening of bids.
- 17.2. In exceptional circumstances, prior to the expiration of the bid validity period, the Procuring Entity may request Bidders to extend the period of validity of their bids. The request and the responses shall be made in writing. The bid security described in ITB Clause 18 should also be extended corresponding to the extension of the bid validity period at the least. A Bidder may refuse the request without forfeiting its bid security, but his bid shall no longer be considered for further evaluation and award. A Bidder granting the request shall not be required or permitted to modify its bid.

18. Bid Security

- 18.1. The Bidder shall submit a Bid Securing Declaration or any form of Bid Security in an amount stated in the BDS, which shall be not less than the percentage of the ABC in accordance with the following schedule:

Form of Bid Security	Amount of Bid Security (Not less than the Percentage of the ABC)

(a) Cash or cashier's/manager's check issued by a Universal or Commercial Bank,	Two percent (2%)
(b) Bank draft/guarantee or irrevocable letter of credit issued by a Universal or Commercial Bank: Provided, however, that it shall be confirmed or authenticated by a Universal or Commercial Bank, if issued by a foreign bank.	
(c) Surety bond callable upon demand issued by a surety or insurance company duly certified by the Insurance Commission as authorized to issue such security;	Five percent (5%)

The Bid Securing Declaration mentioned above is an undertaking which states, among others, that the Bidder shall enter into contract with the procuring entity and furnish the performance security required under ITB Clause 32.2, within ten (10) calendar days from receipt of the Notice of Award, and commits to pay the corresponding amount as fine, and be suspended for a period of time from being qualified to participate in any government procurement activity in the event it violates any of the conditions stated therein as provided in the guidelines issued by the GPPB.

- 18.2. The bid security should be valid for the period specified in the **BDS**. Any bid not accompanied by an acceptable bid security shall be rejected by the Procuring Entity as non-responsive.
- 18.3. No bid securities shall be returned to Bidders after the opening of bids and before contract signing, except to those that failed or declared as post-disqualified, upon submission of a written waiver of their right to file a request for reconsideration and/or protest, or lapse of the reglementary period without having filed a request for reconsideration or protest. Without prejudice on its forfeiture, Bid Securities shall be returned only after the Bidder with the Lowest Calculated Responsive Bid (LCRB) has signed the contract and furnished the Performance Security, but in no case later than the expiration of the Bid Security validity period indicated in ITB Clause 18.2.
- 18.4. Upon signing and execution of the contract, pursuant to ITB Clause 31, and the posting of the performance security, pursuant to ITB Clause 32, the successful Bidder's Bid Security will be discharged, but in no case later than the Bid Security validity period as indicated in ITB Clause 18.2.
- 18.5. The bid security may be forfeited:
- (a) if a Bidder:

- (i) withdraws its bid during the period of bid validity specified in ITB Clause 17;
 - (ii) does not accept the correction of errors pursuant to ITB Clause 27.3(b);
 - (iii) has a finding against the veracity of the required documents submitted in accordance with ITB Clause 28.2;
 - (iv) submission of eligibility requirements containing false information or falsified documents.
 - (v) submission of bids that contain false information or falsified documents, or the concealment of such information in the bids in order to influence the outcome of eligibility screening or any other stage of the public bidding;
 - (vi) allowing the use of one's name, or using the name of another for purposes of public bidding;
 - (vii) withdrawal of a bid, or refusal to accept an award, or enter into contract with the Government without justifiable cause, after the Bidder had been adjudged as having submitted the LCRB;
 - (viii) refusal or failure to post the required performance security within the prescribed time;
 - (ix) refusal to clarify or validate in writing its bid during post-qualification within a period of seven (7) calendar days from receipt of the request for clarification;
 - (x) any documented attempt by a Bidder to unduly influence the outcome of the bidding in his favor;
 - (xi) failure of the potential joint venture partners to enter into the joint venture after the bid is declared successful; or
 - (xii) all other acts that tend to defeat the purpose of the competitive bidding, such as habitually withdrawing from bidding, submitting late Bids or patently insufficient bid, for at least three (3) times within a year, except for valid reasons.
- (b) if the successful Bidder:
- (i) fails to sign the contract in accordance with ITB Clause 31;
 - (ii) fails to furnish performance security in accordance with ITB Clause 32.

19. Format and Signing of Bids

Handwritten signature and initials, possibly 'N. J. K.', with a checkmark to the right.

- 19.1 Bidders shall submit their bids through their duly authorized representative using the appropriate forms provided in Section IX Bidding Forms
- 19.2 Forms on or before the deadline specified in the ITB Clause 21 in two (2) separate sealed bid envelopes, and which shall be submitted simultaneously. The first shall contain the technical component of the bid, including the eligibility requirements under ITB Clause 12.1, and the second shall contain the financial component of the bid. This shall also be observed for each lot in the case of lot procurement.
- 19.3 Forms as mentioned in ITB Clause 19.1 must be completed without any alterations to their format, and no substitute form shall be accepted. All blank spaces shall be filled in with the information requested.
- 19.4 The Bidder shall prepare and submit an original of the first and second envelopes as described in ITB Clauses 12 and 13. In addition, the Bidder shall submit copies of the first and second envelopes. In the event of any discrepancy between the original and the copies, the original shall prevail.
- 19.5 Each and every page of the Bid Form, including the Bill of Quantities, under Section IX hereof, shall be signed by the duly authorized representative/s of the Bidder. Failure to do so shall be a ground for the rejection of the bid.
- 19.6 Any interlineations, erasures, or overwriting shall be valid only if they are signed or initialed by the duly authorized representative/s of the Bidder.

20. Sealing and Marking of Bids

- 20.1. Bidders shall enclose their original eligibility and technical documents described in ITB Clause 12, in one sealed envelope marked "ORIGINAL - TECHNICAL COMPONENT," and the original of their financial component in another sealed envelope marked "ORIGINAL - FINANCIAL COMPONENT," sealing them all in an outer envelope marked "ORIGINAL BID."
- 20.2. Each copy of the first and second envelopes shall be similarly sealed duly marking the inner envelopes as "COPY NO. ___ - TECHNICAL COMPONENT" and "COPY NO. ___ - FINANCIAL COMPONENT" and the outer envelope as "COPY NO. ___," respectively. These envelopes containing the original and the copies shall then be enclosed in one single envelope.

- 20.3. The original and the number of copies of the bid as indicated in the **BDS** shall be typed or written in ink and shall be signed by the Bidder or its duly authorized representative/s.
- 20.4. All envelopes shall:
- (a) contain the name of the contract to be bid in capital letters;
 - (b) bear the name and address of the Bidder in capital letters;
 - (c) be addressed to the Procuring Entity's BAC in accordance with ITB Clause 21;
 - (d) bear the specific identification of this bidding process indicated in the ITB Clause 1.2; and
 - (e) bear a warning "DO NOT OPEN BEFORE..." the date and time for the opening of bids, in accordance with ITB Clause 21.
- 20.5. Bid envelopes that are not properly sealed and marked, as required in the bidding documents, shall not be rejected, but the Bidder or its duly authorized representative shall acknowledge such condition of the bid as submitted. The BAC or the Procuring Entity shall assume no responsibility for the misplacement of the contents of the improperly sealed or marked bid, or for its premature opening.

D. Submission and Opening of Bids

21. Deadline for Submission of Bids

Bids must be received by the Procuring Entity's BAC at the address and on or before the date and time indicated in the **BDS**. In case the deadline for submission of bids fall on a non-working day duly declared by the president, governor or mayor or other government official authorized to make such declaration, the deadline shall be the next working day

22. Late Bids

Any bid submitted after the deadline for submission and receipt of bids prescribed by the Procuring Entity, pursuant to ITB Clause 21, shall be declared "Late" and shall not be accepted by the Procuring Entity. The BAC shall record in the minutes of Bid Submission and Opening, the Bidder's name, its representative and the time the late bid was submitted.

23. Modification and Withdrawal of Bids

- 23.1. The Bidder may modify its bid after it has been submitted; provided that the modification is received by the Procuring Entity prior to the deadline prescribed for submission and receipt of bids. The Bidder shall not be allowed to retrieve its original bid, but shall be allowed to submit another bid equally sealed and properly identified in accordance with Clause 20, linked to its

Handwritten signature and initials in black ink, appearing to be 'J. S. G. P. M.' with a flourish at the end.

original bid marked as "TECHNICAL MODIFICATION" or "FINANCIAL MODIFICATION" and stamped "received" by the BAC. Bid modifications received after the applicable deadline shall not be considered and shall be returned to the Bidder unopened.

- 23.2. A Bidder may, through a Letter of Withdrawal, withdraw its bid after it has been submitted, for valid and justifiable reason; provided that the Letter of Withdrawal is received by the Procuring Entity prior to the deadline prescribed for submission and receipt of bids. The Letter of Withdrawal must be executed by the authorized representative of the Bidder identified in the Omnibus Sworn Statement, a copy of which should be attached to the letter.
- 23.3. Bids requested to be withdrawn in accordance with ITB Clause 23.1 shall be returned unopened to the Bidders. A Bidder, who has acquired the bidding documents may also express its intention not to participate in the bidding through a letter which should reach and be stamped by the BAC before the deadline for submission and receipt of bids. A Bidder that withdraws its bid shall not be permitted to submit another bid, directly or indirectly, for the same contract.
- 23.4. No bid may be modified after the deadline for submission of bids. No bid may be withdrawn in the interval between the deadline for submission of bids and the expiration of the period of bid validity specified by the Bidder on the Financial Bid Form. Withdrawal of a bid during this interval shall result in the forfeiture of the Bidder's bid security, pursuant to ITB Clause 18.5, and the imposition of administrative, civil, and criminal sanctions as prescribed by RA 9184 and its IRR.

24. Opening and Preliminary Examination of Bids

- 24.1. The BAC shall open the Bids in public, immediately after the deadline for the submission and receipt of bids in public, as specified in the BDS. In case the Bids cannot be opened as scheduled due to justifiable reasons, the BAC shall take custody of the Bids submitted and reschedule the opening of Bids on the next working day or at the soonest possible time through the issuance of a Notice of Postponement to be posted in the PhilGEPS website and the website of the Procuring Entity concerned.
- 24.2. Unless otherwise specified in the BDS, the BAC shall open the first bid envelopes and determine each Bidder's compliance with the documents prescribed in ITB Clause 12, using a non-discretionary "pass/fail" criterion. If a Bidder submits the required document, it shall be rated "passed" for that particular requirement. In this regard, bids that fail to include any requirement or are incomplete or patently insufficient shall be considered as "failed". Otherwise, the BAC shall rate the said first bid envelope as "passed".
- 24.3. Unless otherwise specified in the BDS, immediately after determining compliance with the requirements in the first envelope, the BAC shall forthwith open the second bid envelope of each remaining eligible Bidder whose first bid envelope was rated "passed." The second envelope of each complying Bidder shall be opened within the same day. In case one or more of

the requirements in the second envelope of a particular bid is missing, incomplete or patently insufficient, and/or if the submitted total bid price exceeds the ABC unless otherwise provided in ITB Clause 13.2, the BAC shall rate the bid concerned as "failed." Only bids that are determined to contain all the bid requirements for both components shall be rated "passed" and shall immediately be considered for evaluation and comparison.

- 24.4. Letters of Withdrawal shall be read out and recorded during bid opening, and the envelope containing the corresponding withdrawn bid shall be returned to the Bidder unopened.
- 24.5. All members of the BAC who are present during bid opening shall initial every page of the original copies of all bids received and opened.
- 24.6. In the case of an eligible foreign bidder as described in ITB Clause 5, the following Class "A" Documents may be substituted with the appropriate equivalent documents, if any, issued by the country of the foreign bidder concerned, which shall likewise be uploaded and maintained in the PhilGEPS in accordance with Section 8.5.2 of the IRR.:
- a) Registration certificate from the Securities and Exchange Commission (SEC), Department of Trade and Industry (DTI) for sole proprietorship, or CDA for cooperatives;
 - b) Mayor's/Business permit issued by the local government where the principal place of business of the Bidder is located; and
 - c) Audited Financial Statements showing, among others, the prospective Bidder's total and current assets and liabilities stamped "received" by the Bureau of Internal Revenue or its duly accredited and authorized institutions, for the preceding calendar year which should not be earlier than two years from the date of bid submission.
- 24.7. Each partner of a joint venture agreement shall likewise submit the document required in ITB Clause 12.1(a)(i). Submission of documents required under ITB Clauses 12.1(a)(ii) to 12.1(a)(iv) by any of the joint venture partners constitutes compliance.
- 24.8. The Procuring Entity shall prepare the minutes of the proceedings of the bid opening that shall include, as a minimum: (a) names of Bidders, their bid price (per lot, if applicable, and/or including discount, if any), bid security, findings of preliminary examination, and whether there is a withdrawal or modification; and (b) attendance sheet. The BAC members shall sign the abstract of bids as read.
- 24.8. The Bidders or their duly authorized representatives may attend the opening of bids. The BAC shall ensure the integrity, security, and confidentiality of all submitted bids. The Abstract of Bids as read and the minutes of the Bid Opening shall be made available to the public upon written request and payment of a specified fee to recover cost of materials.



- 24.9 To ensure transparency and accurate representation of the bid submission, the BAC Secretariat shall notify in writing all Bidders whose bids it has received through its PhilGEPS-registered physical address or official e-mail address. The notice shall be issued within seven (7) calendar days from the date of the bid opening.

E. Evaluation and Comparison of Bids

25. Process to be Confidential

- 25.1. Members of the BAC, including its staff and personnel, as well as its Secretariat and TWG, are prohibited from making or accepting any kind of communication with any Bidder regarding the evaluation of their bids until the issuance of the Notice of Award, unless otherwise allowed in the case of ITB Clause 26.
- 25.2. Any effort by a Bidder to influence the Procuring Entity in the Procuring Entity's decision in respect of bid evaluation, bid comparison or contract award will result in the rejection of the Bidder's bid.

26. Clarification of Bids

To assist in the evaluation, comparison and post-qualification of the bids, the Procuring Entity may ask in writing any Bidder for a clarification of its bid. All responses to requests for clarification shall be in writing. Any clarification submitted by a Bidder in respect to its bid and that is not in response to a request by the Procuring Entity shall not be considered.

27. Detailed Evaluation and Comparison of Bids

- 27.1. The Procuring Entity will undertake the detailed evaluation and comparison of Bids which have passed the opening and preliminary examination of Bids, pursuant to ITB Clause 24, in order to determine the Lowest Calculated Bid.
- 27.2. The Lowest Calculated Bid shall be determined in two steps:
- (a) The detailed evaluation of the financial component of the bids, to establish the correct calculated prices of the bids; and
 - (b) The ranking of the total bid prices as so calculated from the lowest to highest. The bid with the lowest price shall be identified as the Lowest Calculated Bid.
- 27.3. The Procuring Entity's BAC shall immediately conduct a detailed evaluation of all bids rated "passed," using non-discretionary "pass/fail" criterion. The BAC shall consider the following in the evaluation of bids:
- (a) Completeness of the bid. Unless the BDS allows partial bids, bids not addressing or providing all of the required items in the Schedule of Requirements including, where applicable, bill of quantities, shall be considered non-responsive and, thus, automatically disqualified. In this

regard, where a required item is provided, but no price is indicated, the same shall be considered as non-responsive, but specifying a zero (0) or a dash (-) for the said item would mean that it is being offered for free to the Procuring Entity, except those required by law or regulations to be provided for; and

- (b) **Arithmetical corrections.** Consider computational errors and omissions to enable proper comparison of all eligible bids. It may also consider bid modifications. Any adjustment shall be calculated in monetary terms to determine the calculated prices.
- 27.4. Based on the detailed evaluation of bids, those that comply with the above-mentioned requirements shall be ranked in the ascending order of their total calculated bid prices, as evaluated and corrected for computational errors, discounts and other modifications, to identify the Lowest Calculated Bid. Total calculated bid prices, as evaluated and corrected for computational errors, discounts and other modifications, which exceed the ABC shall not be considered, unless otherwise indicated in the **BDS**.
- 27.5. The Procuring Entity's evaluation of bids shall be based on the bid price quoted in the Bid Form, which includes the Bill of Quantities.
- 27.6. Bids shall be evaluated on an equal footing to ensure fair competition. For this purpose, all Bidders shall be required to include in their bids the cost of all taxes, such as, but not limited to, value added tax (VAT), income tax, local taxes, and other fiscal levies and duties which shall be itemized in the bid form and reflected in the detailed estimates. Such bids, including said taxes, shall be the basis for bid evaluation and comparison.
- 27.7. If so indicated pursuant to ITB Clause 1.2. Bids are being invited for individual lots or for any combination thereof, provided that all Bids and combinations of Bids shall be received by the same deadline and opened and evaluated simultaneously so as to determine the bid or combination of bids offering the lowest calculated cost to the Procuring Entity. Bid prices quoted shall correspond to all of the requirements specified for each lot. Bid Security as required by ITB Clause 18 shall be submitted for each contract (lot) separately. The basis for evaluation of lots is specified in BDS Clause 27.3.

28. Post Qualification

- 28.1. The BAC shall determine to its satisfaction whether the Bidder that is evaluated as having submitted the Lowest Calculated Bid complies with and is responsive to all the requirements and conditions specified in ITB Clauses 5, 12, and 13.
- 28.2. Within a non-extendible period of five (5) calendar days from receipt by the Bidder of the notice from the BAC that it submitted the Lowest Calculated Bid, the Bidder shall submit its latest income and business tax returns filed and paid through the BIR Electronic Filing and Payment System (eFPS) and other appropriate licenses and permits required by law and stated in the **BDS**.

Failure to submit any of the post-qualification requirements on time, or a finding against the veracity thereof, shall disqualify the Bidder for award. Provided in the event that a finding against the veracity of any of the documents submitted is made, it shall cause the forfeiture of the bid security in accordance with Section 69 of the IRR of RA 9184.

- 28.3. The determination shall be based upon an examination of the documentary evidence of the Bidder's qualifications submitted pursuant to ITB Clauses 12 and 13, as well as other information as the Procuring Entity deems necessary and appropriate, using a non-discretionary "pass/fail" criterion, which shall be completed within a period of twelve (12) calendar days.
- 28.4. If the BAC determines that the Bidder with the Lowest Calculated Bid passes all the criteria for post-qualification, it shall declare the said bid as the LCRB, and recommend to the HoPE the award of contract to the said Bidder at its submitted price or its calculated bid price, whichever is lower, subject to ITB Clause 30.3.
- 28.5. A negative determination shall result in rejection of the Bidder's bid, in which event the Procuring Entity shall proceed to the next Lowest Calculated Bid, with a fresh period to make a similar determination of that Bidder's capabilities to perform satisfactorily. If the second Bidder, however, fails the post qualification, the procedure for post qualification shall be repeated for the Bidder with the next Lowest Calculated Bid, and so on until the LCRB is determined for recommendation of contract award.
- 28.6. Within a period not exceeding fifteen (15) calendar days from the determination by the BAC of the LCRB and the recommendation to award the contract, the HoPE or his duly authorized representative shall approve or disapprove the said recommendation.
- 28.7. In the event of disapproval, which shall be based on valid, reasonable, and justifiable grounds as provided for under Section 41 of the IRR of RA 9184, the HoPE shall notify the BAC and the Bidder in writing of such decision and the grounds for it. When applicable, the BAC shall conduct a post-qualification of the Bidder with the next Lowest Calculated Bid. A request for reconsideration may be filed by the Bidder with the HoPE in accordance with Section 37.1.3 of the IRR of RA 9184.

29. Reservation Clause

- 29.1. Notwithstanding the eligibility or post-qualification of a Bidder, the Procuring Entity concerned reserves the right to review its qualifications at any stage of the procurement process if it has reasonable grounds to believe that a misrepresentation has been made by the said Bidder, or that there has been a change in the Bidder's capability to undertake the project from the time it submitted its eligibility requirements. Should such review uncover any misrepresentation made in the eligibility and bidding requirements, statements or documents, or any changes in the situation of the Bidder which will affect its capability to undertake the project so that it fails the preset eligibility or bid evaluation criteria, the Procuring Entity shall consider the said Bidder as

ineligible and shall disqualify it from submitting a bid or from obtaining an award or contract.

29.2. Based on the following grounds, the Procuring Entity reserves the right to reject any and all Bids, declare a Failure of Bidding at any time prior to the contract award, or not to award the contract, without thereby incurring any liability, and make no assurance that a contract shall be entered into as a result of the bidding:

- (a) If there is *prima facie* evidence of collusion between appropriate public officers or employees of the Procuring Entity; or between the BAC and any of the Bidders, or if the collusion is between or among the Bidders themselves, or between a Bidder and a third party, including any act which restricts, suppresses or nullifies or tends to restrict, suppress or nullify competition;
- (b) If the Procuring Entity's BAC is found to have failed in following the prescribed bidding procedures; or
- (c) For any justifiable and reasonable ground where the award of the contract will not redound to the benefit of the GOP as follows:
 - (i) If the physical and economic conditions have significantly changed so as to render the project no longer economically, financially or technically feasible as determined by the HoPE;
 - (ii) If the project is no longer necessary as determined by the HoPE; and
 - (iii) If the source of funds for the project has been withheld or reduced through no fault of the Procuring Entity.

29.3. In addition, the Procuring Entity may likewise declare a failure of bidding when:

- (a) No bids are received;
- (b) All prospective Bidders are declared ineligible;
- (c) All bids fail to comply with all the bid requirements, fail post-qualification; or
- (d) The Bidder with the LCRB refuses, without justifiable cause, to accept the award of contract, and no award is made in accordance with Section 40 of the IRR of RA 9184.

F. Award of Contract

30. Contract Award



- 30.1. Subject to ITB Clause 28, the HoPE or its duly authorized representative shall award the contract to the Bidder whose bid has been determined to be the LCRB.
- 30.2. Prior to the expiration of the period of bid validity, the Procuring Entity shall notify the successful Bidder in writing that its bid has been accepted, through a Notice of Award duly received by the Bidder or its representative personally or by registered mail or electronically, receipt of which must be confirmed in writing within two (2) days by the Bidder with the LCRB and submitted personally or sent by registered mail or electronically to the Procuring Entity.
- 30.3. Notwithstanding the issuance of the Notice of Award, award of contract shall be subject to the following conditions:
 - (a) Submission of valid PCAB license and registration for the type and cost of the contract to be bid for foreign bidders when the Treaty or International or Executive Agreement expressly allows submission of the PCAB license and registration for the type and cost of the contract to be bid as a pre-condition to the Award, within ten (10) calendar days from receipt of the Notice of Award;
 - (b) Posting of the performance security in accordance with ITB Clause 32;
 - (c) Signing of the contract as provided in ITB Clause 31; and
 - (d) Approval by higher authority, if required, as provided in Section 37.3 of the IRR of RA 9184.

31. Signing of the Contract

- 31.1. At the same time as the Procuring Entity notifies the successful Bidder that its bid has been accepted, the Procuring Entity shall send the Contract Form to the Bidder, which Contract has been provided in the Bidding Documents, incorporating therein all agreements between the parties.
- 31.2. Within ten (10) calendar days from receipt of the Notice of Award, the successful Bidder shall post the required performance security, sign and date the contract and return it to the Procuring Entity.
- 31.3. The Procuring Entity shall enter into contract with the successful Bidder within the same ten (10) calendar day period provided that all the documentary requirements are complied with.
- 31.4. The following documents shall form part of the contract:
 - (a) Contract Agreement;
 - (b) Bidding Documents;
 - (c) Winning Bidder's bid, including the Technical and Financial Proposals, and all other documents/statements submitted (e.g., Bidder's response to request for clarifications on the bid), including

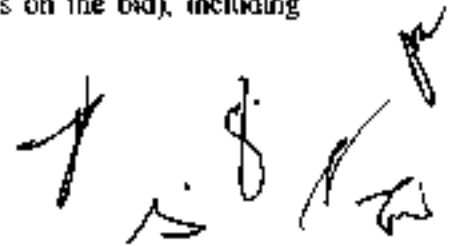

corrections to the bid, if any, resulting from the Procuring Entity's bid evaluation;

- (d) Performance Security;
- (e) Notice of Award of Contract; and
- (f) Other contract documents that may be required by existing laws and/or specified in the BDS.

32. Performance Security

- 32.1. To guarantee the faithful performance by the winning Bidder of its obligations under the contract, it shall post a performance security within a maximum period of ten (10) calendar days from the receipt of the Notice of Award from the Procuring Entity and in no case later than the signing of the contract.
- 32.2. The Performance Security shall be denominated in Philippine Pesos and posted in favor of the Procuring Entity in an amount not less than the percentage of the total contract price in accordance with the following schedule:

Form of Performance Security	Amount of Performance Security (Not less than the Percentage of the Total Contract Price)
(a) Cash or cashier's/manager's check issued by a Universal or Commercial Bank.	Ten percent (10%)
(b) Bank draft/guarantee or irrevocable letter of credit issued by a Universal or Commercial Bank: Provided, however, that it shall be confirmed or authenticated by a Universal or Commercial Bank, if issued by a foreign bank.	
(c) Surety bond callable upon demand issued by a surety or insurance company duly certified by the Insurance Commission as authorized to issue such security.	Thirty percent (30%)

- 32.3. Failure of the successful Bidder to comply with the above-mentioned requirement shall constitute sufficient ground for the annulment of the award and forfeiture of the bid security, in which event the Procuring Entity shall have a fresh period to initiate and complete the post qualification of the second Lowest Calculated Bid. The procedure shall be repeated until LCRB is identified and selected for recommendation of contract award. However if no

Bidder passed post-qualification, the BAC shall declare the bidding a failure and conduct a re-bidding with re-advertisement, if necessary.

33. Notice to Proceed

Within seven (7) calendar days from the date of approval of the Contract by the appropriate government approving authority, the Procuring Entity shall issue the Notice to Proceed (NTP) together with a copy or copies of the approved contract to the successful Bidder. All notices called for by the terms of the contract shall be effective only at the time of receipt thereof by the successful Bidder.

34. Protest Mechanism

Decision of the procuring entity at any stage of the procurement process may be questioned in accordance with Sections 55 of the IRR of RA 9184.



Section III. Bid Data Sheet

ITB Clause	
1.1	The Procuring Entity is Philippine Health Insurance Corporation (PhilHealth)
2	The Funding Source is: COB CY2018 in the amount of One Million Five Hundred Sixty Four Thousand Five Hundred Four Pesos (PhP1,564,504.00) . The name of the Project is: Procurement of Three (3) Lots Leasehold Improvement (ITB No. LI 2018-01-Infra)
3.1	No further instructions.
5.1	No further instructions.
5.2	Foreign bidders, except those falling under ITB Clause, may not participate in this Project.
5.4(b)	For this purpose, similar contracts shall refer to contracts which have the same major categories of work. Civil Works
8.1	Subcontracting is not allowed
8.2	Not applicable
9.1	The BAC-INFRA will hold a PRE-BID CONFERENCE for this Project on January 17, 2019, 10:30 a.m. at SBAC Conference Area, Room 1004, 10th Floor Citystate Centre Bldg., 709 Shaw Blvd., Bgy. Oranbo, Pasig City.
10.1	PhilHealth's address is: Room 1003, 10th Floor, Citystate Center, 709 Shaw Boulevard, Oranbo, Pasig City; Telefax No. 637-4735 Email Address: maximel@philhealth.gov.ph / sprad@philhealth.gov.ph
12.1	No further instructions.
12.1(a)(iii)	No further instructions.
13.1(b)	This shall include all of the following documents: 1) Detailed estimates, including a summary sheet indicating the unit prices of construction materials, labor rates, and equipment rentals used in coming up with the Bid; and 2) Cash flow by quarter or payment schedule.
13.2	The ABC is One Million Five Hundred Sixty Four Thousand Five Hundred Four Pesos (PhP1,564,504.00) . Any bid with a financial component exceeding this amount shall not be accepted.
14.2	No further instructions.
16.1	The bid prices shall be quoted in Philippine Pesos .
16.3	No further instructions.
17.1	Bids will be valid until 120 days .
18.1	The bid security shall be in the form of a Bid Securing Declaration or any of the following forms and amounts: 1. The amount of not less than Thirty-One Thousand Two Hundred Ninety & 08/100 Pesos (PhP31,290.08) , if bid security is in cash.

Handwritten marks and scribbles at the top of the page.

<p>2. The amount of not less than Seventy-Eight Thousand Two Hundred credit; cashier's/manager's check, bank draft/guarantee or irrevocable letter of Bond.</p>	
<p>The bid security shall be valid until 120 days</p>	18.2
<p>Each bidder shall submit one (1) master envelope which contains the two (2) envelopes and drop in the bid box. The first envelope shall be labeled as "ORIGINAL BID", containing the "ORIGINAL, TECHNICAL COMPONENT" AND "ORIGINAL FINANCIAL COMPONENT". The second envelope shall be labeled as "DUPLICATOR", containing "DUPLICATOR" - TECHNICAL COMPONENT" AND "DUPLICATOR" - FINANCIAL COMPONENT". All copies of the TECHNICAL and FINANCIAL COMPONENTS of the Bid (Original and Duplicate) shall be signed, and each and every page thereof shall be initialed by the duly authorized representative/s of the Bidder with page number clearly indicated. Each type of document should be properly tabbed/labeled.</p> <p>Non-compliance may be a ground for disqualification at the discretion of the BAC.</p> <p>The address for submission of bids is at SBAC Conference Room, Room 1003, 10th Floor, Cuyahoga Center, 709 Shaw Boulevard, Cranberry, Youngstown, OH 44321.</p> <p>The deadline for submission of bids is January 29, 2019, 10:30 AM.</p> <p>In case the deadline for submission of bids fall on a non-working day duly declared by the president, governor or mayor or other government official authorized to make such declaration, the deadline shall be the next working day.</p>	20.3
<p>The place of bid opening is at SBAC Conference Room, Room 1004, 10th Floor, Cuyahoga Center, 709 Shaw Boulevard, Cranberry, Youngstown, OH 44321.</p> <p>The date and time of bid opening is January 29, 2019, 10:30 AM.</p>	24.1
<p>No further instructions.</p>	24.2
<p>No further instructions.</p>	24.3
<p>No further instructions.</p>	27.4

Section IV. General Conditions of Contract

1. Definitions

For purposes of this Clause, boldface type is used to identify defined terms.

- 1.1. The **Arbiter** is the person appointed jointly by the Procuring Entity and the Contractor to resolve disputes in the first instance, as provided for in GCC Clause 21.
- 1.2. **Bill of Quantities** refers to a list of the specific items of the Work and their corresponding unit prices, lump sums, and/or provisional sums.
- 1.3. The **Completion Date** is the date of completion of the Works as certified by the Procuring Entity's Representative, in accordance with GCC Clause 49.
- 1.4. The **Contract** is the contract between the Procuring Entity and the Contractor to execute, complete, and maintain the Works.
- 1.5. The **Contract Effectivity Date** is the date of signing of the Contract. However, the contractor shall commence execution of the Works on the Start Date as defined in GCC Clause 1.28.
- 1.6. The **Contract Price** is the price stated in the Notice of Award and thereafter to be paid by the Procuring Entity to the Contractor for the execution of the Works in accordance with this Contract.
- 1.7. **Contract Time Extension** is the allowable period for the Contractor to complete the Works in addition to the original Completion Date stated in this Contract.
- 1.8. The **Contractor** is the juridical entity whose proposal has been accepted by the Procuring Entity and to whom the Contract to execute the Work was awarded.
- 1.9. The **Contractor's Bid** is the signed offer or proposal submitted by the Contractor to the Procuring Entity in response to the Bidding Documents.
- 1.10. **Days** are calendar days; months are calendar months.
- 1.11. **Dayworks** are varied work inputs subject to payment on a time basis for the Contractor's employees and Equipment, in addition to payments for associated Materials and Plant.
- 1.12. A **Defect** is any part of the Works not completed in accordance with the Contract.
- 1.13. The **Defects Liability Certificate** is the certificate issued by Procuring Entity's Representative upon correction of defects by the Contractor.
- 1.14. The **Defects Liability Period** is the one year period between contract completion and final acceptance within which the Contractor assumes the responsibility to undertake the repair of any damage to the Works at his own expense.
- 1.15. **Drawings** are graphical presentations of the Works. They include all supplementary details, shop drawings, calculations, and other information provided or approved for the execution of this Contract.
- 1.16. **Equipment** refers to all facilities, supplies, appliances, materials or things required for the execution and completion of the Work provided by the Contractor and which shall not form or are not intended to form part of the Permanent Works.
- 1.17. The **Intended Completion Date** refers to the date specified in the **SCC** when the Contractor is expected to have completed the Works. The Intended

Handwritten signature and initials in black ink, located at the bottom right of the page.

- Completion Date may be revised only by the Procuring Entity's Representative by issuing an extension of time or an acceleration order.
- 1.18 **Materials** are all supplies, including consumables, used by the Contractor for incorporation in the Works.
- 1.19 **The Notice to Proceed** is a written notice issued by the Procuring Entity or the Procuring Entity's Representative to the Contractor requiring the latter to begin the commencement of the work not later than a specified or determinable date.
- 1.20 **Permanent Works** are all permanent structures and all other project features and facilities required to be constructed and completed in accordance with this Contract which shall be delivered to the Procuring Entity and which shall remain at the Site after the removal of all Temporary Works.
- 1.21 **Plant** refers to the machinery, apparatus, and the like intended to form an integral part of the Permanent Works.
- 1.22 **The Procuring Entity** is the party who employs the Contractor to carry out the Works stated in the SCC.
- 1.23 **The Procuring Entity's Representative** refers to the Head of the Procuring Entity or his duly authorized representative, identified in the SCC, who shall be responsible for supervising the execution of the Works and administering this Contract.
- 1.24 **The Site** is the place provided by the Procuring Entity where the Works shall be executed and any other place or places which may be designated in the SCC, or notified to the Contractor by the Procuring Entity's Representative as forming part of the Site.
- 1.25 **Site Investigation Reports** are those that were included in the Bidding Documents and are factual and interpretative reports about the surface and subsurface conditions at the Site.
- 1.26 **Slippage** is a delay in work execution occurring when actual accomplishment falls below the target as measured by the difference between the scheduled and actual accomplishment of the Work by the Contractor as established from the work schedule. This is actually described as a percentage of the whole Works.
- 1.27 **Specifications** means the description of Works to be done and the qualities of materials to be used, the equipment to be installed and the mode of construction.
- 1.28 **The Start Date**, as specified in the SCC, is the date when the Contractor is obliged to commence execution of the Works. It does not necessarily coincide with any of the Site Possession Dates.
- 1.29 A **Subcontractor** is any person or organization to whom a part of the Works has been subcontracted by the Contractor, as allowed by the Procuring Entity, but not any assignee of such person.
- 1.30 **Temporary Works** are works designed, constructed, installed, and removed by the Contractor that are needed for construction or installation of the Permanent Works.
- 1.31 **Work(s)** refer to the Permanent Works and Temporary Works to be executed by the Contractor in accordance with this Contract, including (i) the furnishing of all labor, materials, equipment and others incidental, necessary or convenient to the complete execution of the Works; (ii) the passing of any tests before acceptance by the Procuring Entity's Representative; (iii) and the carrying out of all duties and obligations of the Contractor imposed by this Contract as described in the SCC.



2. Interpretation

- 2.1. In interpreting the Conditions of Contract, singular also means plural, male also means female or neuter, and the other way around. Headings have no significance. Words have their normal meaning under the language of this Contract unless specifically defined. The Procuring Entity's Representative will provide instructions clarifying queries about the Conditions of Contract.
- 2.2. If sectional completion is specified in the SCC, references in the Conditions of Contract to the Works, the Completion Date, and the Intended Completion Date apply to any Section of the Works (other than references to the Completion Date and Intended Completion Date for the whole of the Works).
- 2.3. The documents forming this Contract shall be interpreted in the following order of priority:
 - a) Contract Agreement;
 - b) Bid Data Sheet,
 - c) Instructions to Bidders,
 - d) Addenda to the Bidding Documents,
 - e) Special Conditions of Contract;
 - f) General Conditions of Contract;
 - g) Specifications;
 - h) Bill of Quantities, and
 - i) Drawings.

3. Governing Language and Law

- 3.1. This Contract has been executed in the English language, which shall be the binding and controlling language for all matters relating to the meaning or interpretation of this Contract. All correspondence and other documents pertaining to this Contract which are exchanged by the parties shall be written in English.
- 3.2. This Contract shall be interpreted in accordance with the laws of the Republic of the Philippines.

4. Communications

Communications between parties that are referred to in the Conditions shall be effective only when in writing. A notice shall be effective only when it is received by the concerned party.

5. Possession of Site



- 5.1. On the date specified in the SCC, the Procuring Entity shall grant the Contractor possession of so much of the Site as may be required to enable it to proceed with the execution of the Works. If the Contractor suffers delay or incurs cost from failure on the part of the Procuring Entity to give possession in accordance with the terms of this clause, the Procuring Entity's Representative shall give the Contractor a Contract Time Extension and certify such sum as fair to cover the cost incurred, which sum shall be paid by Procuring Entity.
- 5.2. If possession of a portion is not given by the date stated in the SCC Clause 5.1, the Procuring Entity will be deemed to have delayed the start of the relevant activities. The resulting adjustments in contract time to address such delay shall be in accordance with GCC Clause 47.
- 5.3. The Contractor shall bear all costs and charges for special or temporary right-of-way required by it in connection with access to the Site. The Contractor shall also provide at his own cost any additional facilities outside the Site required by it for purposes of the Works.
- 5.4. The Contractor shall allow the Procuring Entity's Representative and any person authorized by the Procuring Entity's Representative access to the Site and to any place where work in connection with this Contract is being carried out or is intended to be carried out.

6. The Contractor's Obligations

- 6.1. The Contractor shall carry out the Works properly and in accordance with this Contract. The Contractor shall provide all supervision, labor, Materials, Plant and Contractor's Equipment, which may be required. All Materials and Plant on Site shall be deemed to be the property of the Procuring Entity.
- 6.2. The Contractor shall commence execution of the Works on the Start Date and shall carry out the Works in accordance with the Program of Work submitted by the Contractor, as updated with the approval of the Procuring Entity's Representative, and complete them by the Intended Completion Date.
- 6.3. The Contractor shall be responsible for the safety of all activities on the Site.
- 6.4. The Contractor shall carry out all instructions of the Procuring Entity's Representative that comply with the applicable laws where the Site is located.
- 6.5. The Contractor shall employ the key personnel named in the Schedule of Key Personnel, as referred to in the SCC, to carry out the supervision of the Works. The Procuring Entity will approve any proposed replacement of key personnel only if their relevant qualifications and abilities are equal to or better than those of the personnel listed in the Schedule.
- 6.6. If the Procuring Entity's Representative asks the Contractor to remove a member of the Contractor's staff or work force, for justifiable cause, the Contractor shall ensure that the person leaves the Site within seven (7) days and has no further connection with the Work in this Contract.



- 6.7. During Contract implementation, the Contractor and his subcontractors shall abide at all times by all labor laws, including child labor related enactments, and other relevant rules.
- 6.8. The Contractor shall submit to the Procuring Entity for consent the name and particulars of the person authorized to receive instructions on behalf of the Contractor.
- 6.9. The Contractor shall cooperate and share the Site with other contractors, public authorities, utilities, and the Procuring Entity between the dates given in the schedule of other contractors particularly when they shall require access to the Site. The Contractor shall also provide facilities and services for them during this period. The Procuring Entity may modify the schedule of other contractors, and shall notify the Contractor of any such modification thereto.
- 6.10. Should anything of historical or other interest or of significant value be unexpectedly discovered on the Site, it shall be the property of the Procuring Entity. The Contractor shall notify the Procuring Entity's Representative of such discoveries and carry out the Procuring Entity's Representative's instructions in dealing with them.

7. Performance Security

- 7.1. Within ten (10) calendar days from receipt of the Notice of Award from the Procuring Entity but in no case later than the signing of the contract by both parties, the Contractor shall furnish the performance security in any of the forms prescribed in ITB Clause 32.2.
- 7.2. The performance security posted in favor of the Procuring Entity shall be forfeited in the event it is established that the Contractor is in default in any of its obligations under the Contract.
- 7.3. The performance security shall remain valid until issuance by the Procuring Entity of the Certificate of Final Acceptance
- 7.4. The performance security may be released by the Procuring Entity and returned to the Contractor after the issuance of the Certificate of Final Acceptance subject to the following conditions:
 - (a) There are no pending claims against the Contractor or the surety company filed by the Procuring Entity;
 - (b) The Contractor has no pending claims for labor and materials filed against it; and
 - (c) Other terms specified in the SCC.
- 7.5. The Contractor shall post an additional performance security following the amount and form specified in ITB Clause 32.2 to cover any cumulative increase of more than ten percent (10%) over the original value of the contract as a result of amendments to order or change orders, extra work orders and

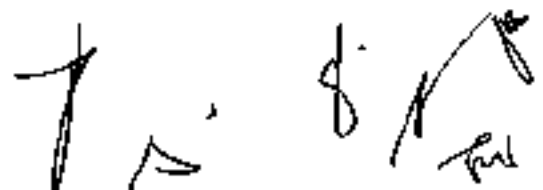

supplemental agreements, as the case may be. The Contractor shall cause the extension of the validity of the performance security to cover approved contract time extensions.

- 7.6. In case of a reduction in the contract value or for partially completed Works under the contract which are usable and accepted by the Procuring Entity the use of which, in the judgment of the implementing agency or the Procuring Entity, will not affect the structural integrity of the entire project, the Procuring Entity shall allow a proportional reduction in the original performance security, provided that any such reduction is more than ten percent (10%) and that the aggregate of such reductions is not more than fifty percent (50%) of the original performance security.
- 7.7. Unless otherwise indicated in the SCC, the Contractor, by entering into the Contract with the Procuring Entity, acknowledges the right of the Procuring Entity to institute action pursuant to Act 3688 against any subcontractor be they an individual, firm, partnership, corporation, or association supplying the Contractor with labor, materials and/or equipment for the performance of this Contract.

8. Subcontracting

- 8.1. Unless otherwise indicated in the SCC, the Contractor cannot subcontract Works more than the percentage specified in BDS Clause 8.1.
- 8.2. Subcontracting of any portion of the Works does not relieve the Contractor of any liability or obligation under this Contract. The Contractor will be responsible for the acts, defaults, and negligence of any subcontractor, its agents, servants or workmen as fully as if these were the Contractor's own acts, defaults, or negligence, or those of its agents, servants or workmen.
- 8.3. If subcontracting is allowed, the contractor may identify its subcontractor during contract implementation stage. Subcontractors disclosed and identified during the bidding may be changed during the implementation of this Contract. In either case, subcontractors must submit the documentary requirements under ITB Clause 12 and comply with the eligibility criteria specified in the BDS. In the event that any subcontractor is found by any Procuring Entity to be eligible, the subcontracting of such portion of the Works shall be disallowed.

9. Liquidated Damages

- 9.1. The Contractor shall pay liquidated damages to the Procuring Entity for each day that the Completion Date is later than the Intended Completion Date. The applicable liquidated damages is at least one-tenth (1/10) of a percent of the cost of the unperformed portion for every day of delay. The total amount of liquidated damages shall not exceed ten percent (10%) of the amount of the contract. The Procuring Entity may deduct liquidated damages from payments due to the Contractor. Payment of liquidated damages shall not affect the

Handwritten signature and initials in black ink, appearing to be 'T. J. G.' with a flourish.

Contractor's liabilities. Once the cumulative amount of liquidated damages reaches ten percent (10%) of the amount of this Contract, the Procuring Entity may rescind or terminate this Contract, without prejudice to other courses of action and remedies available under the circumstances.

- 9.2. If the Intended Completion Date is extended after liquidated damages have been paid, the Engineer of the Procuring Entity shall correct any overpayment of liquidated damages by the Contractor by adjusting the next payment certificate.

10. Site Investigation Reports

The Contractor, in preparing the Bid, shall rely on any Site Investigation Reports referred to in the SCC supplemented by any information obtained by the Contractor.

11. The Procuring Entity, Licenses and Permits

The Procuring Entity shall, if requested by the Contractor, assist him in applying for permits, licenses or approvals, which are required for the Works.

12. Contractor's Risk and Warranty Security

- 12.1. The Contractor shall assume full responsibility for the Works from the time project construction commenced up to final acceptance by the Procuring Entity and shall be held responsible for any damage or destruction of the Works except those occasioned by *force majeure*. The Contractor shall be fully responsible for the safety, protection, security, and convenience of his personnel, third parties, and the public at large, as well as the Works, Equipment, installation, and the like to be affected by his construction work.
- 12.2. The defects liability period for infrastructure projects shall be one year from contract completion up to final acceptance by the Procuring Entity. During this period, the Contractor shall undertake the repair works, at his own expense, of any damage to the Works on account of the use of materials of inferior quality within ninety (90) days from the time the HoPE has issued an order to undertake repair. In case of failure or refusal to comply with this mandate, the Procuring Entity shall undertake such repair works and shall be entitled to full reimbursement of expenses incurred therein upon demand.
- 12.3. Unless otherwise indicated in the SCC, in case the Contractor fails to comply with the preceding paragraph, the Procuring Entity shall forfeit its performance security, subject its property(ies) to attachment or garnishment proceedings, and perpetually disqualify it from participating in any public bidding. All payables of the GoP in his favor shall be offset to recover the costs.
- 12.4. After final acceptance of the Works by the Procuring Entity, the Contractor shall be held responsible for "Structural Defects," i.e., major faults/flaws/deficiencies in one or more key structural elements of the project which may lead to structural failure of the completed elements or structure, or "Structural Failures," i.e., where one or more key structural elements in an



infrastructure facility fails or collapses, thereby rendering the facility or part thereof incapable of withstanding the design loads, and/or endangering the safety of the users or the general public:

- (a) Contractor – Where Structural Defects/Failures arise due to faults attributable to improper construction, use of inferior quality/substandard materials, and any violation of the contract plans and specifications, the contractor shall be held liable;
- (b) Consultants – Where Structural Defects/Failures arise due to faulty and/or inadequate design and specifications as well as construction supervision, then the consultant who prepared the design or undertook construction supervision for the project shall be held liable;
- (c) Procuring Entity's Representatives/Project Manager/Construction Managers and Supervisors – The project owner's representative(s), project manager, construction manager, and supervisor(s) shall be held liable in cases where the Structural Defects/Failures are due to his/their willful intervention in altering the designs and other specifications; negligence or omission in not approving or acting on proposed changes to noted defects or deficiencies in the design and/or specifications; and the use of substandard construction materials in the project;
- (d) Third Parties - Third Parties shall be held liable in cases where Structural Defects/Failures are caused by work undertaken by them such as leaking pipes, diggings or excavations, underground cables and electrical wires, underground tunnel, mining shaft and the like, in which case the applicable warranty to such structure should be levied to third parties for their construction or restoration works.
- (e) Users - In cases where Structural Defects/Failures are due to abuse/misuse by the end user of the constructed facility and/or non-compliance by a user with the technical design limits and/or intended purpose of the same, then the user concerned shall be held liable.

12.5. The warranty against Structural Defects/Failures, except those occasioned on force majeure, shall cover the period specified in the SCC reckoned from the date of issuance of the Certificate of Final Acceptance by the Procuring Entity.

12.6. The Contractor shall be required to put up a warranty security in the form of cash, bank guarantee, letter of credit, GSIS or surety bond callable on demand, in accordance with the following schedule:

Form of Warranty	Amount of Warranty Security Not less than the Percentage (%) of Total Contract Price
(a) Cash or letter of credit issued by Universal or Commercial bank: provided, however, that the letter of credit shall be confirmed or authenticated by a Universal or	Five Percent (5%)

Commercial bank, if issued by a foreign bank	
(b) Bank guarantee confirmed by Universal or Commercial bank; provided, however, that the letter of credit shall be confirmed or authenticated by a Universal or Commercial bank, if issued by a foreign bank	Ten Percent (10%)
(c) Surety bond callable upon demand issued by GSIS or any surety or insurance company duly certified by the Insurance Commission	Thirty Percent (30%)

12.7. The warranty security shall be stated in Philippine Pesos and shall remain effective for one year from the date of issuance of the Certificate of Final Acceptance by the Procuring Entity, and returned only after the lapse of said one year period.

12.8. In case of structural defects/failure occurring during the applicable warranty period provided in GCC Clause 12.5, the Procuring Entity shall undertake the necessary restoration or reconstruction works and shall be entitled to full reimbursement by the parties found to be liable for expenses incurred therein upon demand, without prejudice to the filing of appropriate administrative, civil, and/or criminal charges against the responsible persons as well as the forfeiture of the warranty security posted in favor of the Procuring Entity.

13. Liability of the Contractor

Subject to additional provisions, if any, set forth in the SCC, the Contractor's liability under this Contract shall be as provided by the laws of the Republic of the Philippines.

14. Procuring Entity's Risk

14.1. From the Start Date until the Certificate of Final Acceptance has been issued, the following are risks of the Procuring Entity:

- (a) The risk of personal injury, death, or loss of or damage to property (excluding the Works, Plant, Materials, and Equipment), which are due to:
 - (i) any type of use or occupation of the Site authorized by the Procuring Entity after the official acceptance of the works; or
 - (ii) negligence, breach of statutory duty, or interference with any legal right by the Procuring Entity or by any person employed by or contracted to him except the Contractor.
- (b) The risk of damage to the Works, Plant, Materials, and Equipment to the extent that it is due to a fault of the Procuring Entity or in the

Procuring Entity's design, or due to war or radioactive contamination directly affecting the country where the Works are to be executed.

15. Insurance

- 15.1. The Contractor shall, under his name and at his own expense, obtain and maintain, for the duration of this Contract, the following insurance coverage:
- (a) Contractor's All Risk Insurance;
 - (b) Transportation to the project Site of Equipment, Machinery, and Supplies owned by the Contractor;
 - (c) Personal injury or death of Contractor's employees; and
 - (d) Comprehensive insurance for third party liability to Contractor's direct or indirect act or omission causing damage to third persons.
- 15.2. The Contractor shall provide evidence to the Procuring Entity's Representative that the insurances required under this Contract have been effected and shall, within a reasonable time, provide copies of the insurance policies to the Procuring Entity's Representative. Such evidence and such policies shall be provided to the Procuring Entity's through the Procuring Entity's Representative.
- 15.3. The Contractor shall notify the insurers of changes in the nature, extent, or program for the execution of the Works and ensure the adequacy of the insurances at all times in accordance with the terms of this Contract and shall produce to the Procuring Entity's Representative the insurance policies in force including the receipts for payment of the current premiums.
- The above insurance policies shall be obtained from any reputable insurance company approved by the Procuring Entity's Representative.
- 15.4. If the Contractor fails to obtain and keep in force the insurances referred to herein or any other insurance which he may be required to obtain under the terms of this Contract, the Procuring Entity may obtain and keep in force any such insurances and pay such premiums as may be necessary for the purpose. From time to time, the Procuring Entity may deduct the amount it shall pay for said premiums including twenty five percent (25%) therein from any monies due, or which may become due, to the Contractor, without prejudice to the Procuring Entity exercising its right to impose other sanctions against the Contractor pursuant to the provisions of this Contract.
- 15.5. In the event the Contractor fails to observe the above safeguards, the Procuring Entity may, at the Contractor's expense, take whatever measure is deemed necessary for its protection and that of the Contractor's personnel and third parties, and/or order the interruption of dangerous Works. In addition, the Procuring Entity may refuse to make the payments under GCC Clause 40 until the Contractor complies with this Clause.

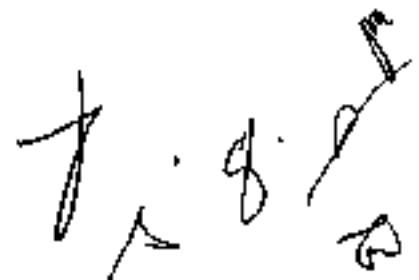
Handwritten signature and initials in black ink, appearing to be 'J. G. S.' with a flourish and a small mark below.

15.6. The Contractor shall immediately replace the insurance policy obtained as required in this Contract, without need of the Procuring Entity's demand, with a new policy issued by a new insurance company acceptable to the Procuring Entity for any of the following grounds:

- (a) The issuer of the insurance policy to be replaced has:
 - (i) become bankrupt;
 - (ii) been placed under receivership or under a management committee;
 - (iii) been sued for suspension of payment; or
 - (iv) been suspended by the Insurance Commission and its license to engage in business or its authority to issue insurance policies cancelled; or
 - (v) Where reasonable grounds exist that the insurer may not be able, fully and promptly, to fulfill its obligation under the insurance policy.

16. Termination for Default of Contractor

16.1. The Procuring Entity shall terminate this Contract for default when any of the following conditions attend its implementation:

- (i) Due to the Contractor's fault and while the project is on-going, it has incurred negative slippage of fifteen percent (15%) or more in accordance with Presidential Decree 1870, regardless of whether or not previous warnings and notices have been issued for the Contractor to improve his performance;
- (ii) Due to its own fault and after this Contract time has expired, the Contractor incurs delay in the completion of the Work after this Contract has expired; or
- (iii) The Contractor:
 - (i) abandons the contract Works, refuses or fails to comply with a valid instruction of the Procuring Entity or fails to proceed expeditiously and without delay despite a written notice by the Procuring Entity;
 - (ii) does not actually have on the project Site the minimum essential equipment listed on the bid necessary to prosecute the Works in accordance with the approved Program of Work and equipment deployment schedule as required for the project;
 - (iii) does not execute the Works in accordance with this Contract or persistently or flagrantly neglects to carry out its obligations under this Contract;

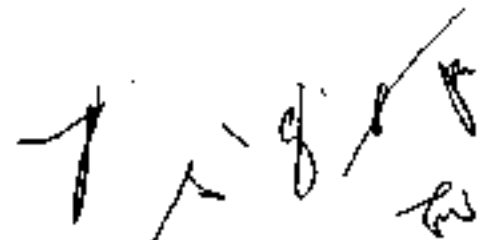
Handwritten signature and initials in black ink, appearing to be 'T. H. G.' with a flourish and 'TW' below it.

- (iv) neglects or refuses to remove materials or to perform a new Work that has been rejected as defective or unsuitable; or
- (v) sub-lets any part of this Contract without approval by the Procuring Entity.

16.2. All materials on the Site, Plant, Works, including Equipment purchased and funded under the Contract shall be deemed to be the property of the Procuring Entity if this Contract is rescinded because of the Contractor's default.

17. Termination for Default of Procuring Entity

The Contractor may terminate this Contract with the Procuring Entity if the works are completely stopped for a continuous period of at least sixty (60) calendar days through no fault of its own, due to any of the following reasons:

- (a) Failure of the Procuring Entity to deliver, within a reasonable time, supplies, materials, right-of-way, or other items it is obligated to furnish under the terms of this Contract, or
- (b) The prosecution of the Work is disrupted by the adverse peace and order situation, as certified by the Armed Forces of the Philippines Provincial Commander and approved by the Secretary of National Defense.

18. Termination for Other Causes

- 18.1. The Procuring Entity may terminate this Contract, in whole or in part, at any time for its convenience. The HoPE may terminate this Contract for the convenience of the Procuring Entity if he has determined the existence of conditions that make Project Implementation economically, financially or technically impractical and/or unnecessary, such as, but not limited to, fortuitous event(s) or changes in law and National Government policies.
- 18.2. The Procuring Entity or the Contractor may terminate this Contract if the other party causes a fundamental breach of this Contract.
- 18.3. Fundamental breaches of Contract shall include, but shall not be limited to, the following:
- (a) The Contractor stops work for twenty eight (28) days when no stoppage of work is shown on the current Program of Work and the stoppage has not been authorized by the Procuring Entity's Representative;
 - (b) The Procuring Entity's Representative instructs the Contractor to delay the progress of the Works, and the instruction is not withdrawn within twenty eight (28) days;
 - (c) The Procuring Entity shall terminate this Contract if the Contractor is declared bankrupt or insolvent as determined with finality by a court of competent jurisdiction. In this event, termination will be without

compensation to the Contractor, provided that such termination will not prejudice or affect any right of action or remedy which has accrued or will accrue thereafter to the Procuring Entity and/or the Contractor. In the case of the Contractor's insolvency, any Contractor's Equipment which the Procuring Entity instructs in the notice is to be used until the completion of the Works;

- (d) A payment certified by the Procuring Entity's Representative is not paid by the Procuring Entity to the Contractor within eighty four (84) days from the date of the Procuring Entity's Representative's certificate;
- (e) The Procuring Entity's Representative gives Notice that failure to correct a particular Defect is a fundamental breach of Contract and the Contractor fails to correct it within a reasonable period of time determined by the Procuring Entity's Representative;
- (f) The Contractor does not maintain a Security, which is required;
- (g) The Contractor has delayed the completion of the Works by the number of days for which the maximum amount of liquidated damages can be paid, as defined in the GCC Clause 9; and
- (h) In case it is determined prima facie by the Procuring Entity that the Contractor has engaged, before or during the implementation of the contract, in unlawful deeds and behaviors relative to contract acquisition and implementation, such as, but not limited to, the following:
 - (i) corrupt, fraudulent, collusive, coercive, and obstructive practices as defined in ITB Clause 3.1(a), unless otherwise specified in the SCC;
 - (ii) drawing up or using forged documents;
 - (iii) using adulterated materials, means or methods, or engaging in production contrary to rules of science or the trade; and
 - (iv) any other act analogous to the foregoing.

18.4. The Funding Source or the Procuring Entity, as appropriate, will seek to impose the maximum civil, administrative and/or criminal penalties available under the applicable law on individuals and organizations deemed to be involved with corrupt, fraudulent, or coercive practices.

18.5. When persons from either party to this Contract gives notice of a fundamental breach to the Procuring Entity's Representative in order to terminate the existing contract for a cause other than those listed under GCC Clause 18.3, the Procuring Entity's Representative shall decide whether the breach is fundamental or not.

Handwritten signature and initials in black ink, appearing to be 'T. S. J. P. A.' with a large 'A' at the bottom right.

18.6. If this Contract is terminated, the Contractor shall stop work immediately, make the Site safe and secure, and leave the Site as soon as reasonably possible.

19. Procedures for Termination of Contracts

19.1. The following provisions shall govern the procedures for the termination of this Contract:

- (a) Upon receipt of a written report of acts or causes which may constitute ground(s) for termination as aforementioned, or upon its own initiative, the Procuring Entity shall, within a period of seven (7) calendar days, verify the existence of such ground(s) and cause the execution of a Verified Report, with all relevant evidence attached;
- (b) Upon recommendation by the Procuring Entity, the HoPE shall terminate this Contract only by a written notice to the Contractor conveying the termination of this Contract. The notice shall state:
 - (i) that this Contract is being terminated for any of the ground(s) afore-mentioned, and a statement of the acts that constitute the ground(s) constituting the same;
 - (ii) the extent of termination, whether in whole or in part;
 - (iii) an instruction to the Contractor to show cause as to why this Contract should not be terminated; and
 - (iv) special instructions of the Procuring Entity, if any.

The Notice to Terminate shall be accompanied by a copy of the Verified Report;

- (c) Within a period of seven (7) calendar days from receipt of the Notice of Termination, the Contractor shall submit to the HoPE a verified position paper stating why the contract should not be terminated. If the Contractor fails to show cause after the lapse of the seven (7) day period, either by inaction or by default, the HoPE shall issue an order terminating the contract;
- (d) The Procuring Entity may, at anytime before receipt of the Contractor's verified position paper described in item (c) above withdraw the Notice to Terminate if it is determined that certain items or works subject of the notice had been completed, delivered, or performed before the Contractor's receipt of the notice;
- (e) Within a non-extendible period of ten (10) calendar days from receipt of the verified position paper, the HoPE shall decide whether or not to terminate this Contract. It shall serve a written notice to the Contractor of its decision and, unless otherwise provided in the said notice, this Contract is deemed terminated from receipt of the Contractor of the

notice of decision. The termination shall only be based on the ground(s) stated in the Notice to Terminate; and

- (f) The HoPE may create a Contract Termination Review Committee (CTRC) to assist him in the discharge of this function. All decisions recommended by the CTRC shall be subject to the approval of the HoPE.

19.2. Pursuant to Section 69(f) of RA 9184 and without prejudice to the imposition of additional administrative sanctions as the internal rules of the agency may provide and/or further criminal prosecution as provided by applicable laws, the procuring entity shall impose on contractors after the termination of the contract the penalty of suspension for one (1) year for the first offense, suspension for two (2) years for the second offense from participating in the public bidding process, for violations committed during the contract implementation stage, which include but not limited to the following:

- (a) Failure of the contractor, due solely to his fault or negligence, to mobilize and start work or performance within the specified period in the Notice to Proceed ("NTP");
- (b) Failure by the contractor to fully and faithfully comply with its contractual obligations without valid cause, or failure by the contractor to comply with any written lawful instruction of the procuring entity or its representative(s) pursuant to the implementation of the contract. For the procurement of Infrastructure projects or consultancy contracts, lawful instructions include but are not limited to the following:
 - (i) Employment of competent technical personnel, competent engineers and/or work supervisors;
 - (ii) Provision of warning signs and barricades in accordance with approved plans and specifications and contract provisions;
 - (iii) Stockpiling in proper places of all materials and removal from the project site of waste and excess materials, including broken pavement and excavated debris in accordance with approved plans and specifications and contract provisions;
 - (iv) Deployment of committed equipment, facilities, support staff and manpower; and
 - (v) Renewal of the effectivity dates of the performance security after its expiration during the course of contract implementation.
- (c) Assignment and subcontracting of the contract or any part thereof or substitution of key personnel named in the proposal without prior written approval by the procuring entity.

Handwritten signature and initials in black ink, appearing to be 'T. S. G.' with a flourish and the letters 'TW' below it.

- (d) Poor performance by the contractor or unsatisfactory quality and/or progress of work arising from his fault or negligence as reflected in the Constructor's Performance Evaluation System ("CPES") rating sheet. In the absence of the CPES rating sheet, the existing performance monitoring system of the procuring entity shall be applied. Any of the following acts by the Contractor shall be construed as poor performance:
- (i) Negative slippage of 15% and above within the critical path of the project due entirely to the fault or negligence of the contractor; and
 - (ii) Quality of materials and workmanship not complying with the approved specifications arising from the contractor's fault or negligence.
- (e) Willful or deliberate abandonment or non-performance of the project or contract by the contractor resulting to substantial breach thereof without lawful and/or just cause.

In addition to the penalty of suspension, the performance security posted by the contractor shall also be forfeited.

20. Force Majeure, Release From Performance

- 20.1. For purposes of this Contract the terms "*force majeure*" and "fortuitous event" may be used interchangeably. In this regard, a fortuitous event or *force majeure* shall be interpreted to mean an event which the Contractor could not have foreseen, or which though foreseen, was inevitable. It shall not include ordinary unfavorable weather conditions; and any other cause the effects of which could have been avoided with the exercise of reasonable diligence by the Contractor.
- 20.2. If this Contract is discontinued by an outbreak of war or by any other event entirely outside the control of either the Procuring Entity or the Contractor, the Procuring Entity's Representative shall certify that this Contract has been discontinued. The Contractor shall make the Site safe and stop work as quickly as possible after receiving this certificate and shall be paid for all works carried out before receiving it and for any Work carried out afterwards to which a commitment was made.
- 20.3. If the event continues for a period of eighty four (84) days, either party may then give notice of termination, which shall take effect twenty eight (28) days after the giving of the notice.
- 20.4. After termination, the Contractor shall be entitled to payment of the unpaid balance of the value of the Works executed and of the materials and Plant reasonably delivered to the Site, adjusted by the following:
- (a) any sum to which the Contractor is entitled under GCC Clause 28;

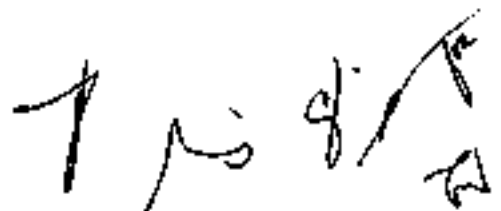

- (b) the cost of his suspension and demobilization;
- (c) any sum to which the Procuring Entity is entitled.

20.5. The net balance due shall be paid or repaid within a reasonable time period from the time of the notice of termination.

21. Resolution of Disputes

- 21.1. If any dispute or difference of any kind whatsoever shall arise between the parties in connection with the implementation of the contract covered by the Act and this IRR, the parties shall make every effort to resolve amicably such dispute or difference by mutual consultation.
- 21.2. If the Contractor believes that a decision taken by the Procuring Entity's Representative was either outside the authority given to the Procuring Entity's Representative by this Contract or that the decision was wrongly taken, the decision shall be referred to the Arbitrator indicated in the SCC within fourteen (14) days of the notification of the Procuring Entity's Representative's decision.
- 21.3. Any and all disputes arising from the implementation of this Contract covered by the R.A. 9184 and its IRR shall be submitted to arbitration in the Philippines according to the provisions of Republic Act No. 876, otherwise known as the "Arbitration Law" and Republic Act 9285, otherwise known as the "Alternative Dispute Resolution Act of 2004"; *Provided, however, That, disputes that are within the competence of the Construction Industry Arbitration Commission to resolve shall be referred thereto. The process of arbitration shall be incorporated as a provision in this Contract that will be executed pursuant to the provisions of the Act and its IRR: Provided, further, That, by mutual agreement, the parties may agree in writing to resort to other alternative modes of dispute resolution.*

22. Suspension of Loan, Credit, Grant, or Appropriation

In the event that the Funding Source suspends the Loan, Credit, Grant, or Appropriation to the Procuring Entity, from which part of the payments to the Contractor are being made:

- (a) The Procuring Entity is obligated to notify the Contractor of such suspension within seven (7) days of having received the suspension notice.
- (b) If the Contractor has not received sums due it for work already done within forty five (45) days from the time the Contractor's claim for payment has been certified by the Procuring Entity's Representative, the Contractor may immediately issue a suspension of work notice in accordance with GCC Clause 45.2.

Handwritten signature and initials in black ink, appearing to be 'T. S. G. P. R.' with a large flourish.

23. Procuring Entity's Representative's Decisions

- 23.1. Except where otherwise specifically stated, the Procuring Entity's Representative will decide contractual matters between the Procuring Entity and the Contractor in the role representing the Procuring Entity.
- 23.2. The Procuring Entity's Representative may delegate any of his duties and responsibilities to other people, except to the Arbitrator, after notifying the Contractor, and may cancel any delegation after notifying the Contractor.

24. Approval of Drawings and Temporary Works by the Procuring Entity's Representative

- 24.1. All Drawings prepared by the Contractor for the execution of the Temporary Works, are subject to prior approval by the Procuring Entity's Representative before its use.
- 24.2. The Contractor shall be responsible for design of Temporary Works.
- 24.3. The Procuring Entity's Representative's approval shall not alter the Contractor's responsibility for design of the Temporary Works.
- 24.4. The Contractor shall obtain approval of third parties to the design of the Temporary Works, when required by the Procuring Entity.

25. Acceleration and Delays Ordered by the Procuring Entity's Representative

- 25.1. When the Procuring Entity wants the Contractor to finish before the Intended Completion Date, the Procuring Entity's Representative will obtain priced proposals for achieving the necessary acceleration from the Contractor. If the Procuring Entity accepts these proposals, the Intended Completion Date will be adjusted accordingly and confirmed by both the Procuring Entity and the Contractor.
- 25.2. If the Contractor's Financial Proposals for an acceleration are accepted by the Procuring Entity, they are incorporated in the Contract Price and treated as a Variation.

26. Extension of the Intended Completion Date

- 26.1. The Procuring Entity's Representative shall extend the Intended Completion Date if a Variation is issued which makes it impossible for the Intended Completion Date to be achieved by the Contractor without taking steps to accelerate the remaining work, which would cause the Contractor to incur additional costs. No payment shall be made for any event which may warrant the extension of the Intended Completion Date.
- 26.2. The Procuring Entity's Representative shall decide whether and by how much to extend the Intended Completion Date within twenty one (21) days of the Contractor asking the Procuring Entity's Representative for a decision thereto

Handwritten signature and initials in black ink, appearing to be 'T. S. G.' with a flourish and 'T.S.' below it.

after fully submitting all supporting information. If the Contractor has failed to give early warning of a delay or has failed to cooperate in dealing with a delay, the delay by this failure shall not be considered in assessing the new Intended Completion Date.

27. Right to Vary

27.1. The Procuring Entity's Representative with the prior approval of the Procuring Entity may instruct Variations, up to a maximum cumulative amount of ten percent (10%) of the original contract cost.

27.2. Variations shall be valued as follows:

- (a) At a lump sum price agreed between the parties;
- (b) where appropriate, at rates in this Contract;
- (c) in the absence of appropriate rates, the rates in this Contract shall be used as the basis for valuation; or failing which
- (d) at appropriate new rates, equal to or lower than current industry rates and to be agreed upon by both parties and approved by the HoPE.

28. Contractor's Right to Claim

If the Contractor incurs cost as a result of any of the events under GCC Clause 13, the Contractor shall be entitled to the amount of such cost. If as a result of any of the said events, it is necessary to change the Works, this shall be dealt with as a Variation.

29. Dayworks

29.1. Subject to GCC Clause 43 on Variation Order, and if applicable as indicated in the SCC, the Dayworks rates in the Contractor's bid shall be used for small additional amounts of work only when the Procuring Entity's Representative has given written instructions in advance for additional work to be paid for in that way.

29.2. All work to be paid for as Dayworks shall be recorded by the Contractor on forms approved by the Procuring Entity's Representative. Each completed form shall be verified and signed by the Procuring Entity's Representative within two days of the work being done.

29.3. The Contractor shall be paid for Dayworks subject to obtaining signed Dayworks forms.

30. Early Warning

30.1. The Contractor shall warn the Procuring Entity's Representative at the earliest opportunity of specific likely future events or circumstances that may adversely affect the quality of the work, increase the Contract Price, or delay the execution of the Works. The Procuring Entity's Representative may

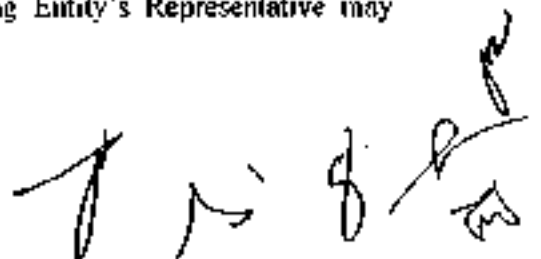

require the Contractor to provide an estimate of the expected effect of the future event or circumstance on the Contract Price and Completion Date. The estimate shall be provided by the Contractor as soon as reasonably possible.

- 30.2. The Contractor shall cooperate with the Procuring Entity's Representative in making and considering proposals for how the effect of such an event or circumstance can be avoided or reduced by anyone involved in the work and in carrying out any resulting instruction of the Procuring Entity's Representative.

31. Program of Work

- 31.1. Within the time stated in the SCC, the Contractor shall submit to the Procuring Entity's Representative for approval a Program of Work showing the general methods, arrangements, order, and timing for all the activities in the Works.
- 31.2. An update of the Program of Work shall show the actual progress achieved on each activity and the effect of the progress achieved on the timing of the remaining work, including any changes to the sequence of the activities.
- 31.3. The Contractor shall submit to the Procuring Entity's Representative for approval an updated Program of Work at intervals no longer than the period stated in the SCC. If the Contractor does not submit an updated Program of Work within this period, the Procuring Entity's Representative may withhold the amount stated in the SCC from the next payment certificate and continue to withhold this amount until the next payment after the date on which the overdue Program of Work has been submitted.
- 31.4. The Procuring Entity's Representative's approval of the Program of Work shall not alter the Contractor's obligations. The Contractor may revise the Program of Work and submit it to the Procuring Entity's Representative again at any time. A revised Program of Work shall show the effect of any approved Variations.
- 31.5. When the Program of Work is updated, the Contractor shall provide the Procuring Entity's Representative with an updated cash flow forecast. The cash flow forecast shall include different currencies, as defined in the Contract, converted as necessary using the Contract exchange rates.
- 31.6. All Variations shall be included in updated Program of Work produced by the Contractor.

32. Management Conferences

- 32.1. Either the Procuring Entity's Representative or the Contractor may require the other to attend a Management Conference. The Management Conference shall review the plans for remaining work and deal with matters raised in accordance with the early warning procedure.

Handwritten signature and initials in black ink, appearing to be 'T N G' followed by a stylized flourish.

32.2. The Procuring Entity's Representative shall record the business of Management Conferences and provide copies of the record to those attending the Conference and to the Procuring Entity. The responsibility of the parties for actions to be taken shall be decided by the Procuring Entity's Representative either at the Management Conference or after the Management Conference and stated in writing to all who attended the Conference.

33. Bill of Quantities

33.1. The Bill of Quantities shall contain items of work for the construction, installation, testing, and commissioning of work to be done by the Contractor.

33.2. The Bill of Quantities is used to calculate the Contract Price. The Contractor is paid for the quantity of the work done at the rate in the Bill of Quantities for each item.

33.3. If the final quantity of any work done differs from the quantity in the Bill of Quantities for the particular item and is not more than twenty five percent (25%) of the original quantity, provided the aggregate changes for all items do not exceed ten percent (10%) of the Contract price, the Procuring Entity's Representative shall make the necessary adjustments to allow for the changes subject to applicable laws, rules, and regulations.

33.4. If requested by the Procuring Entity's Representative, the Contractor shall provide the Procuring Entity's Representative with a detailed cost breakdown of any rate in the Bill of Quantities.

34. Instructions, Inspections and Audits

34.1. The Procuring Entity's personnel shall at all reasonable times during construction of the Work be entitled to examine, inspect, measure and test the materials and workmanship, and to check the progress of the construction.

34.2. If the Procuring Entity's Representative instructs the Contractor to carry out a test not specified in the Specification to check whether any work has a defect and the test shows that it does, the Contractor shall pay for the test and any samples. If there is no defect, the test shall be a Compensation Event.

34.3. The Contractor shall permit the Funding Source named in the SCC to inspect the Contractor's accounts and records relating to the performance of the Contractor and to have them audited by auditors appointed by the Funding Source, if so required by the Funding Source.

35. Identifying Defects

The Procuring Entity's Representative shall check the Contractor's work and notify the Contractor of any defects that are found. Such checking shall not affect the Contractor's responsibilities. The Procuring Entity's Representative may instruct the Contractor to search uncover defects and test any work that the Procuring Entity's Representative considers below standards and defective.

Handwritten signature and initials in black ink, appearing to be 'T. N. G. J. W.' with a flourish at the end.

36. Cost of Repairs

Loss or damage to the Works or Materials to be incorporated in the Works between the Start Date and the end of the Defects Liability Periods shall be remedied by the Contractor at the Contractor's cost if the loss or damage arises from the Contractor's acts or omissions.

37. Correction of Defects

37.1. The Procuring Entity's Representative shall give notice to the Contractor of any defects before the end of the Defects Liability Period, which is One (1) year from project completion up to final acceptance by the Procuring Entity's Representative.

37.2. Every time notice of a defect is given, the Contractor shall correct the notified defect within the length of time specified in the Procuring Entity's Representative's notice.

37.3. The Contractor shall correct the defects which he notices himself before the end of the Defects Liability Period.

37.4. The Procuring Entity shall certify that all defects have been corrected. If the Procuring Entity considers that correction of a defect is not essential, he can request the Contractor to submit a quotation for the corresponding reduction in the Contract Price. If the Procuring Entity accepts the quotation, the corresponding change in the SCC is a Variation.

38. Uncorrected Defects

38.1. The Procuring Entity shall give the Contractor at least fourteen (14) days notice of his intention to use a third party to correct a Defect. If the Contractor does not correct the Defect himself within the period, the Procuring Entity may have the Defect corrected by the third party. The cost of the correction will be deducted from the Contract Price.

38.2. The use of a third party to correct defects that are uncorrected by the Contractor will in no way relieve the Contractor of its liabilities and warranties under the Contract.

39. Advance Payment

39.1. The Procuring Entity shall, upon a written request of the contractor which shall be submitted as a contract document, make an advance payment to the contractor in an amount not exceeding fifteen percent (15%) of the total contract price, to be made in lump sum or, at the most two, installments according to a schedule specified in the SCC.

39.2. The advance payment shall be made only upon the submission to and acceptance by the Procuring Entity of an irrevocable standby letter of credit of equivalent value from a commercial bank, a bank guarantee or a surety bond



callable upon demand, issued by a surety or insurance company duly licensed by the Insurance Commission and confirmed by the Procuring Entity.

- 39.3. The advance payment shall be repaid by the Contractor by an amount equal to the percentage of the total contract price used for the advance payment.
- 39.4. The contractor may reduce his standby letter of credit or guarantee instrument by the amounts refunded by the Monthly Certificates in the advance payment.
- 39.5. The Procuring Entity will provide an Advance Payment on the Contract Price as stipulated in the Conditions of Contract, subject to the maximum amount stated in SCC Clause 39.1.

40. Progress Payments

- 40.1. The Contractor may submit a request for payment for Work accomplished. Such request for payment shall be verified and certified by the Procuring Entity's Representative/Project Engineer. Except as otherwise stipulated in the SCC, materials and equipment delivered on the site but not completely put in place shall not be included for payment.
- 40.2. The Procuring Entity shall deduct the following from the certified gross amounts to be paid to the contractor as progress payment:
 - (a) Cumulative value of the work previously certified and paid for.
 - (b) Portion of the advance payment to be recouped for the month.
 - (c) Retention money in accordance with the condition of contract.
 - (d) Amount to cover third party liabilities.
 - (e) Amount to cover uncorrected discovered defects in the works.
- 40.3. Payments shall be adjusted by deducting therefrom the amounts for advance payments and retention. The Procuring Entity shall pay the Contractor the amounts certified by the Procuring Entity's Representative within twenty eight (28) days from the date each certificate was issued. No payment of interest for delayed payments and adjustments shall be made by the Procuring Entity.
- 40.4. The first progress payment may be paid by the Procuring Entity to the Contractor provided that at least twenty percent (20%) of the work has been accomplished as certified by the Procuring Entity's Representative.
- 40.5. Items of the Works for which a price of "0" (zero) has been entered will not be paid for by the Procuring Entity and shall be deemed covered by other rates and prices in the Contract.

41. Payment Certificates



- 41.1. The Contractor shall submit to the Procuring Entity's Representative monthly statements of the estimated value of the work executed less the cumulative amount certified previously.
- 41.2. The Procuring Entity's Representative shall check the Contractor's monthly statement and certify the amount to be paid to the Contractor.
- 41.3. The value of Work executed shall:
- (a) be determined by the Procuring Entity's Representative;
 - (b) comprise the value of the quantities of the items in the Bill of Quantities completed; and
 - (c) include the valuations of approved variations.
- 41.4. The Procuring Entity's Representative may exclude any item certified in a previous certificate or reduce the proportion of any item previously certified in any certificate in the light of later information.

42. Retention

- 42.1. The Procuring Entity shall retain from each payment due to the Contractor an amount equal to a percentage thereof using the rate as specified in GCC Sub-Clause 42.2.
- 42.2. Progress payments are subject to retention of ten percent (10%), referred to as the "retention money." Such retention shall be based on the total amount due to the Contractor prior to any deduction and shall be retained from every progress payment until fifty percent (50%) of the value of Works, as determined by the Procuring Entity, are completed. If, after fifty percent (50%) completion, the Work is satisfactorily done and on schedule, no additional retention shall be made; otherwise, the ten percent (10%) retention shall again be imposed using the rate specified therefor.
- 42.3. The total "retention money" shall be due for release upon final acceptance of the Works. The Contractor may, however, request the substitution of the retention money for each progress billing with irrevocable standby letters of credit from a commercial bank, bank guarantees or surety bonds callable on demand, of amounts equivalent to the retention money substituted for and acceptable to the Procuring Entity, provided that the project is on schedule and is satisfactorily undertaken. Otherwise, the ten (10%) percent retention shall be made. Said irrevocable standby letters of credit, bank guarantees and/or surety bonds, to be posted in favor of the Government shall be valid for a duration to be determined by the concerned implementing office/agency or Procuring Entity and will answer for the purpose for which the ten (10%) percent retention is intended, i.e., to cover uncorrected discovered defects and third party liabilities.

- 42.4. On completion of the whole Works, the Contractor may substitute retention money with an "on demand" Bank guarantee in a form acceptable to the Procuring Entity.

43. Variation Orders

- 43.1. Variation Orders may be issued by the Procuring Entity to cover any increase/decrease in quantities, including the introduction of new work items that are not included in the original contract or reclassification of work items that are either due to change of plans, design or alignment to suit actual field conditions resulting in disparity between the preconstruction plans used for purposes of bidding and the "as staked plans" or construction drawings prepared after a joint survey by the Contractor and the Procuring Entity after award of the contract, provided that the cumulative amount of the Variation Order does not exceed ten percent (10%) of the original project cost. The addition/deletion of Works should be within the general scope of the project as bid and awarded. The scope of works shall not be reduced so as to accommodate a positive Variation Order. A Variation Order may either be in the form of a Change Order or Extra Work Order.
- 43.2. A Change Order may be issued by the Procuring Entity to cover any increase/decrease in quantities of original Work items in the contract.
- 43.3. An Extra Work Order may be issued by the Procuring Entity to cover the introduction of new work necessary for the completion, improvement or protection of the project which were not included as items of Work in the original contract, such as, where there are subsurface or latent physical conditions at the site differing materially from those indicated in the contract, or where there are duly unknown physical conditions at the site of an unusual nature differing materially from those ordinarily encountered and generally recognized as inherent in the Work or character provided for in the contract.
- 43.4. Any cumulative Variation Order beyond ten percent (10%) shall be subject of another contract to be bid out if the works are separable from the original contract. In exceptional cases where it is urgently necessary to complete the original scope of work, the HoPE may authorize a positive Variation Order go beyond ten percent (10%) but not more than twenty percent (20%) of the original contract price, subject to the guidelines to be determined by the GPPB: *Provided, however*, That appropriate sanctions shall be imposed on the designer, consultant or official responsible for the original detailed engineering design which failed to consider the Variation Order beyond ten percent (10%).
- 43.5. In claiming for any Variation Order, the Contractor shall, within seven (7) calendar days after such work has been commenced or after the circumstances leading to such condition(s) leading to the extra cost, and within twenty-eight (28) calendar days deliver a written communication giving full and detailed particulars of any extra cost in order that it may be investigated at that time. Failure to provide either of such notices in the time stipulated shall constitute a waiver by the contractor for any claim. The preparation and submission of Variation Orders are as follows:

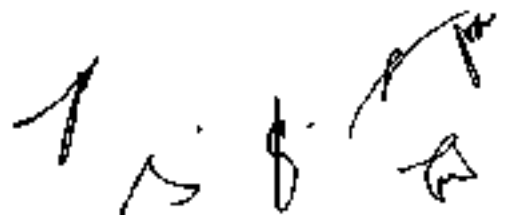
Handwritten signature and initials in black ink, located at the bottom right of the page.

- (a) If the Procuring Entity's representative/Project Engineer believes that a Change Order or Extra Work Order should be issued, he shall prepare the proposed Order accompanied with the notices submitted by the Contractor, the plans therefor, his computations as to the quantities of the additional works involved per item indicating the specific stations where such works are needed, the date of his inspections and investigations thereon, and the log book thereof, and a detailed estimate of the unit cost of such items of work, together with his justifications for the need of such Change Order or Extra Work Order, and shall submit the same to the HoPE for approval.
- (b) The HoPE or his duly authorized representative, upon receipt of the proposed Change Order or Extra Work Order shall immediately instruct the appropriate technical staff or office of the Procuring Entity to conduct an on-the-spot investigation to verify the need for the Work to be prosecuted and to review the proposed plan, and prices of the work involved.
- (c) The technical staff or appropriate office of the Procuring Entity shall submit a report of their findings and recommendations, together with the supporting documents, to the Head of Procuring Entity or his duly authorized representative for consideration.
- (d) The HoPE or his duly authorized representative, acting upon the recommendation of the technical staff or appropriate office, shall approve the Change Order or Extra Work Order after being satisfied that the same is justified, necessary, and in order.
- (e) The timeframe for the processing of Variation Orders from the preparation up to the approval by the Procuring Entity concerned shall not exceed thirty (30) calendar days.

44. Contract Completion

Once the project reaches an accomplishment of ninety five (95%) of the total contract amount, the Procuring Entity may create an inspectorate team to make preliminary inspection and submit a punch-list to the Contractor in preparation for the final turnover of the project. Said punch-list will contain, among others, the remaining Works, Work deficiencies for necessary corrections, and the specific duration/time to fully complete the project considering the approved remaining contract time. This, however, shall not preclude the claim of the Procuring Entity for liquidated damages.

45. Suspension of Work

45.1. The Procuring Entity shall have the authority to suspend the work wholly or partly by written order for such period as may be deemed necessary, due to *force majeure* or any fortuitous events or for failure on the part of the Contractor to correct bad conditions which are unsafe for workers or for the general public, to carry out valid orders given by the Procuring Entity or to perform any provisions of the contract, or due to adjustment of plans to suit

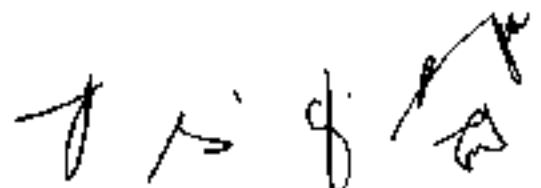

field conditions as found necessary during construction. The Contractor shall immediately comply with such order to suspend the work wholly or partly.

45.2. The Contractor or its duly authorized representative shall have the right to suspend work operation on any or all projects/activities along the critical path of activities after fifteen (15) calendar days from date of receipt of written notice from the Contractor to the district engineer/regional director/consultant or equivalent official, as the case may be, due to the following:

- (a) There exist right-of-way problems which prohibit the Contractor from performing work in accordance with the approved construction schedule.
- (b) Requisite construction plans which must be owner-furnished are not issued to the contractor precluding any work called for by such plans.
- (c) Peace and order conditions make it extremely dangerous, if not possible, to work. However, this condition must be certified in writing by the Philippine National Police (PNP) station which has responsibility over the affected area and confirmed by the Department of Interior and Local Government (DILG) Regional Director.
- (d) There is failure on the part of the Procuring Entity to deliver government-furnished materials and equipment as stipulated in the contract.
- (e) Delay in the payment of Contractor's claim for progress billing beyond forty-five (45) calendar days from the time the Contractor's claim has been certified to by the procuring entity's authorized representative that the documents are complete unless there are justifiable reasons thereof which shall be communicated in writing to the Contractor.

45.3. In case of total suspension, or suspension of activities along the critical path, which is not due to any fault of the Contractor, the elapsed time between the effectivity of the order suspending operation and the order to resume work shall be allowed the Contractor by adjusting the contract time accordingly.

46. Payment on Termination

46.1. If the Contract is terminated because of a fundamental breach of Contract by the Contractor, the Procuring Entity's Representative shall issue a certificate for the value of the work done and Materials ordered less advance payments received up to the date of the issue of the certificate and less the percentage to apply to the value of the work not completed, as indicated in the SCC. Additional Liquidated Damages shall not apply. If the total amount due to the Procuring Entity exceeds any payment due to the Contractor, the difference shall be a debt payable to the Procuring Entity.

46.2. If the Contract is terminated for the Procuring Entity's convenience or because of a fundamental breach of Contract by the Procuring Entity, the Procuring Entity's Representative shall issue a certificate for the value of the work done,

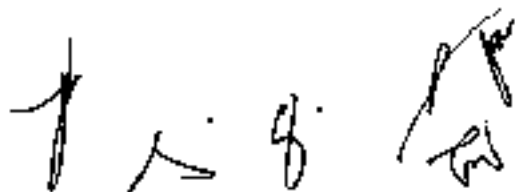

Materials ordered, the reasonable cost of removal of Equipment, repatriation of the Contractor's personnel employed solely on the Works, and the Contractor's costs of protecting and securing the Works, and less advance payments received up to the date of the certificate.

- 46.3. The net balance due shall be paid or repaid within twenty eight (28) days from the notice of termination.
- 46.4. If the Contractor has terminated the Contract under GCC Clauses 17 or 18, the Procuring Entity shall promptly return the Performance Security to the Contractor.

47. Extension of Contract Time

- 47.1. Should the amount of additional work of any kind or other special circumstances of any kind whatsoever occur such as to fairly entitle the contractor to an extension of contract time, the Procuring Entity shall determine the amount of such extension; provided that the Procuring Entity is not bound to take into account any claim for an extension of time unless the Contractor has, prior to the expiration of the contract time and within thirty (30) calendar days after such work has been commenced or after the circumstances leading to such claim have arisen, delivered to the Procuring Entity notices in order that it could have investigated them at that time. Failure to provide such notice shall constitute a waiver by the Contractor of any claim. Upon receipt of full and detailed particulars, the Procuring Entity shall examine the facts and extent of the delay and shall extend the contract time completing the contract work when, in the Procuring Entity's opinion, the findings of facts justify an extension.
- 47.2. No extension of contract time shall be granted the Contractor due to (a) ordinary unfavorable weather conditions and (b) inexcusable failure or negligence of Contractor to provide the required equipment, supplies or materials.
- 47.3. Extension of contract time may be granted only when the affected activities fall within the critical path of the PERT/CPM network.
- 47.4. No extension of contract time shall be granted when the reason given to support the request for extension was already considered in the determination of the original contract time during the conduct of detailed engineering and in the preparation of the contract documents as agreed upon by the parties before contract perfection.
- 47.5. Extension of contract time shall be granted for rainy/unworkable days considered unfavorable for the prosecution of the works at the site, based on the actual conditions obtained at the site, in excess of the number of rainy/unworkable days pre-determined by the Procuring Entity in relation to the original contract time during the conduct of detailed engineering and in the preparation of the contract documents as agreed upon by the parties before contract perfection, and/or for equivalent period of delay due to major calamities such as exceptionally destructive typhoons, floods and earthquakes,



and epidemics, and for causes such as non-delivery on time of materials, working drawings, or written information to be furnished by the Procuring Entity, non-acquisition of permit to enter private properties or non-execution of deed of sale or donation within the right-of-way resulting in complete paralyzation of construction activities, and other meritorious causes as determined by the Procuring Entity's Representative and approved by the HoPE. Shortage of construction materials, general labor strikes, and peace and order problems that disrupt construction operations through no fault of the Contractor may be considered as additional grounds for extension of contract time provided they are publicly felt and certified by appropriate government agencies such as DTT, DOLE, DILG, and DND, among others. The written consent of bondsmen must be attached to any request of the Contractor for extension of contract time and submitted to the Procuring Entity for consideration and the validity of the Performance Security shall be correspondingly extended.

48. Price Adjustment

Except for extraordinary circumstances as determined by NEDA and approved by the GPPB, no price escalation shall be allowed. Nevertheless, in cases where the cost of the awarded contract is affected by any applicable new laws, ordinances, regulations, or other acts of the GoP, promulgated after the date of bid opening, a contract price adjustment shall be made or appropriate relief shall be applied on a no loss-no gain basis.

49. Completion

The Contractor shall request the Procuring Entity's Representative to issue a certificate of Completion of the Works, and the Procuring Entity's Representative will do so upon deciding that the work is completed.

50. Taking Over

The Procuring Entity shall take over the Site and the Works within seven (7) days from the date the Procuring Entity's Representative issues a certificate of Completion.

51. Operating and Maintenance Manuals

- 51.1 If "as built" Drawings and/or operating and maintenance manuals are required, the Contractor shall supply them by the dates stated in the SCC.
- 51.2. If the Contractor does not supply the Drawings and/or manuals by the dates stated in the SCC, or they do not receive the Procuring Entity's Representative's approval, the Procuring Entity's Representative shall withhold the amount stated in the SCC from payments due to the Contractor.



Section V. Special Conditions of Contract





GCC Clause	
1.17	<p>The Intended Completion Date is { _____ }.</p> <p><i>NOTE: The contract duration shall be reckoned from the start date and not from contract effectivity date.</i></p>
1.22	<p>The Procuring Entity is <i>Philippine Health Insurance Corporation</i>.</p>
1.23	<p><i>Philippine Health Insurance Corporation Room 1003, 10th Floor, Citystate Center, 709 Shaw Boulevard, Oranbo, Pasig City; Telefax No. 637-4735</i></p> <p>Email Address: <i>maximol@philhealth.gov.ph/sprriad@philhealth.gov.ph</i></p>
1.24	<p>The Site is located at <i>Citystate Center, 709 Shaw Boulevard, Oranbo, Pasig City</i> and is defined in drawings No.</p>
1.28	<p>The Start Date is <i>The start date shall be the date of receipt of the Notice to Proceed.</i></p>
1.31	<p>The Works consist of <i>{insert a brief summary, including relationship to other contracts under this Project}</i></p>
2.2	<p><i>If different dates are specified for completion of the Works by section ("sectional completion"), these dates should be listed here</i></p>
5.1	<p>The Procuring Entity shall give possession of all parts of the Site to the Contractor <i>{insert date}</i>.</p>
6.5	<p>The Contractor shall employ the following Key Personnel:</p> <p><i>{List key personnel by name and designation}</i></p> <p><i>NOTE: The names of the Key Personnel and their designation shall be filled out by winning contractor prior to contract signing.</i></p>
7.4(c)	<p><i>Specify additional conditions, if any, that must be met prior to the release of the performance security. otherwise, state "No further instructions."</i></p>
7.7	<p>No further instructions.</p>
8.1	<p>No further instructions</p>
10	<p>The site investigation reports are: <i>{list here or state none}</i></p>
12.3	<p>No further instructions.</p>
12.5	<p><i>Select one, delete the other.</i></p> <p><i>In case of permanent structures, such as buildings of types 4 and 5 as classified under the National Building Code of the Philippines and other structures made of steel, iron, or concrete which comply with relevant structural codes (e.g., DPWH Standard Specifications), such as, but not limited to, steel/concrete bridges, flyovers, aircraft movement areas, ports, dams, tunnels, filtration and treatment plants, sewerage systems,</i></p>

Handwritten signature and initials in the bottom right corner of the page.

[Handwritten signatures and initials]

51.1	The date by which operating and maintenance manuals are required is [date].
40.1	Materials and equipment delivered on the site but not completely put in place shall be included for payment. No further instructions. Or Select one and delete the other.
39.1	The amount of the advance payment is [insert amount as percentage of the Contract Price and schedule of payment]
34.3	The Funding Source is the Government of the Philippines.
31.3	The amount to be withheld for late submission of an updated Program of Work is [insert amount]. The period between Program of Work updates is [insert number] days.
31.1	The Contractor shall submit the Program of Work to the Procuring Entity's Representative within [insert number] days of delivery of the Notice of Award.
29.1	Days/works are applicable at the rate shown in the Contractor's original Bid. Or No days/works are applicable to the contract Select one, delete the other:
21.2	The Arbitrator is: [insert name] [insert address]
18.3(h)(i)	No further instructions.
13	State here "No additional provision" or, if the Contractor is a joint venture, "All partners to the joint venture shall be jointly and severally liable to the Procuring Entity."
	In case of semi-permanent structures, such as buildings of types 1, 2, and 3 as classified under the National Building Code of the Philippines, concrete/asphalt roads, concrete river control, drainage, irrigation lined canals, river landing, deep wells, rock causeway, pedestrian overpass, and other similar semi-permanent structures: Five (5) years. In case of other structures, such as Bailey and wooden bridges, shallow wells, spring developments, and other similar structures: Two (2) years.

51.2	The amount to be withheld for failing to produce "as built" drawings and/or operating and maintenance manuals by the date required is [amount in local currency].
	The date by which "as built" drawings are required is [date].

Section VI. Specifications

Lot 1-Leasehold Improvement @ Room 1603

I. BASIC INFORMATION

Project Name : Leasehold Improvement of the OSM-Treasury Department at Room 1603

Location : 16th Floor, Room 1603, CityState Building
709 Shaw Blvd, Pega, Oranbo, Pasig City

Duration : Twenty (20) calendar days

II. SCOPE OF WORKS

The Contractor shall coordinate with the Building Maintenance Unit of General Services and Bldg. Maintenance Division (GSBMD/PRID) immediately after receipt of Contract/Job Order to discuss the schedule of activities and methodology of the project.

The work to be done consists of furnishing all materials, tools, equipment and labor and performing all procedure necessary for the satisfactory completion of the project based on the technical drawing, material specification and this Technical Specifications:

1. Supply and Installation of DryWall Partitions
 - a. Furnish and install Drywall Partitions including its ceiling cornices and baseboards according to the approved technical drawings and specifications including its necessary support for its stability and durability;
 - b. Furnish and install Glass Door at Office of the Senior Manager according to the approved technical drawings and specifications including hinges, handles and lock;
 - c. Furnish and install Flush Door at Conference Room according to the approved technical drawings and specifications including hinges, handles and lock;
 - d. Furnish and install Viewing Glass Windows at Office of the Senior Manager and Conference Room according to the approved technical drawings and specifications;
 - e. Install frosted stickers on Viewing Glass Windows and Glass Door per approved design/lay-out.

2. Application of Paints
 - a. Apply at least three (3) coats of paints as indicated in the technical drawing including all affected wooden items such as ceiling cornices, baseboards, door and jambs.
Color swatches shall be submitted to the End User thru GSBMD Representative for approval prior to application.

3. Supply and Installation of Electrical System
 - a. Supply and install electrical outlets according to the electrical power layout;
 - b. Re-install electrical lighting system according to the electrical lighting layout;
 - c. Provide electrical wires, conduit, fixtures and other pertaining items necessary to complete the new electrical system.

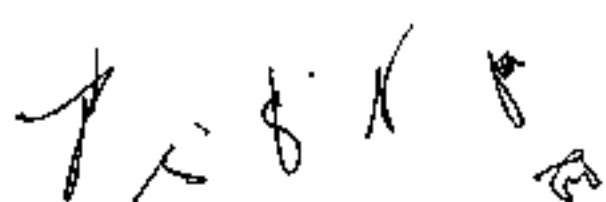

III. PAYMENT

Payment shall be made within fifteen (15) working days upon completion of the following documentary requirement:

1. Delivery Receipt/Sales Invoice/Billing Statement
2. Signed Inspection Report and Acceptance Report
3. Signed Certificate of Acceptance by authorized Signatories

IV. MISCELLANEOUS PROVISIONS

1. Other materials and/or works necessary to complete the project in acceptable and satisfactory manner which are not particularly specified herein shall be supplied, performed and finished by the Contractor/Supplier without additional cost to PhilHealth;
2. During workdays (Monday to Friday), all works shall be done only after every office hours which is 6:00PM until 5:00AM;
3. During weekends (Saturday and Sunday), there is no restricted time of works;
4. Cover/protect all existing properties in the area before commencement of actual improvement activities.
5. Clean-up project site after a day-to-day work activity. Construction debris shall be disposed to the location identified by PhilHealth Building Maintenance Unit.
6. Coordinate with PhilHealth Building Maintenance Unit at Room 1508, CityState Bldg., Tel./Fax. No.: 706-4811 for issuance of Working Permit/Gate Pass and for other related concerns;
7. The Contractor/Supplier shall assume full responsibility for the Works from the time project construction commenced up to final acceptance by PhilHealth and shall be held responsible for any damage or destruction of the Works except those occasioned by *force majeure*. The Contractor/Supplier shall be fully responsible for the safety, protection, security, and convenience of his personnel, third parties, and the public at large, as well as the Works, Equipment, installation, and the like to be affected by his construction work;
8. The Defects Liability Period shall be one (1) year from contract completion. The Certificate of Acceptance shall be issued by PhilHealth after all defects have been corrected. During this period, the Contractor shall undertake the repair works, at his own expense, of any damage to the Works on account of the use of materials of inferior quality within seven (7) days from the time PhilHealth has issued an order to undertake repair. In case of failure or refusal to comply with this mandate, PhilHealth shall undertake such repair works and shall be entitled to full reimbursement of expenses incurred therein upon demand.

Lot 2-Leasehold Improvement @ Room 1906

I. BASIC INFORMATION

Project Name	:	Leasehold Improvement of Room 1906 of CityState Building
Location	:	19 th Floor, Room 1906, CityState Building 709 Shaw Blvd., Brgy. Oranbo, Pasig City
Duration	:	Twenty (20) calendar days

II. SCOPE OF WORKS

The Contractor shall coordinate with the Building Maintenance Unit of General Services and Bldg. Maintenance Division (GSBMD/PRID) immediately after receipt of Contract/Job Order to discuss the schedule of activities and methodology of the project.

The work to be done consists of furnishing all materials, tools, equipment and labor and performing all procedure necessary for the satisfactory completion of the project based on the technical drawing, material specification and this Technical Specifications:

1. Demolition/Removal of Drywall Partition
 - b. Remove existing drywall partition included all affected items such as jambs, electrical fixtures and its components such as electrical wires, utility boxes, switches, convenience outlets, wirings and conduits;
 - c. Remove existing glass door and its components;
 - d. Remove existing hanging cabinets included all affected items;
 - e. Remove existing hanging cabinet at pantry area included all affected items;
 - b. All demolished materials/debris to be disposed shall be presented to PhilHealth Building Maintenance Unit for inspection prior for its disposal outside the building premises;
 - c. Turn-over all reusable material/items to PhilHealth Building Maintenance Unit.
2. Restoration, Cleaning and Repainting of Ceiling Boards and frames
 - a. Restore ceiling system affected by partition wall demolition;
 - b. Clean and paint all ceiling boards (color white);
 - c. Clean all ceiling board framings.
3. Supply and Installation of Glass Partitions
 - f. Furnish and install wall-to-ceiling glass wall partition according to the approved specification including its necessary support for its stability and durability;
 - g. Furnish and install Glass Door according to the approved specification including hinges, handles and lock;
 - h. Apply adequate sealant throughout glass joints.
 - i. Install frosted stickers on main door per approved design/lay-out.
4. Supply and Installation of Hanging Cabinet at Pantry Area
 - a. Furnish and install hanging cabinet as indicated in detailed drawing.
5. Application of Paints
 - b. Prepare walls for the ready application of paints by patching/filling uneven wall surfaces;
 - c. Apply at least three (3) coatings of good quality paints on all interior concrete walls and drywalls;
 - d. Apply at least two (2) coatings of enamel paint on all interior wooden items such as ceiling cornices, baseboards, door and jambs

Color swatches shall be submitted to the End User thru GSBMD Representative for approval prior to application.

III. PAYMENT

Payment shall be made within fifteen (15) working days upon completion of the following documentary requirement:

1. Delivery Receipt/Sales Invoice/Billing Statement
2. Signed Inspection Report and Acceptance Report
3. Signed Certificate of Acceptance by authorized Signatories

IV. MISCELLANEOUS PROVISIONS

1. Other materials and/or works necessary to complete the project in acceptable and satisfactory manner which are not particularly specified herein shall be supplied, performed and finished by the Contractor/Supplier without additional cost to PhilHealth;
2. During workdays (Monday to Friday), all works shall be done only after every office hours which is 6:00PM until 5:00AM;
3. During weekends (Saturday and Sunday), there is no restricted time of works;
4. Cover/protect all existing properties in the area before commencement of actual improvement activities.
5. Clean-up project site after a day-to-day work activity. Construction debris shall be disposed to the location identified by PhilHealth Building Maintenance Unit;
6. Coordinate with PhilHealth Building Maintenance Unit at Room 1508, CityState Bldg., Tel./Fax. No. 706-4811 for issuance of Working Permit/Gate Pass and for other related concerns;
7. The Contractor/Supplier shall assume full responsibility for the Works from the time project construction commenced up to final acceptance by PhilHealth and shall be held responsible for any damage or destruction of the Works except those occasioned by *force majeure*. The Contractor/Supplier shall be fully responsible for the safety, protection, security, and convenience of his personnel, third parties, and the public at large, as well as the Works, Equipment, installation, and the like to be affected by his construction work;
8. The Defects Liability Period shall be one (1) year from contract completion. The Certificate of Acceptance shall be issued by PhilHealth after all defects have been corrected. During this period, the Contractor shall undertake the repair works, at his own expense, of any damage to the Works on account of the use of materials of inferior quality within seven (7) days from the time PhilHealth has issued an order to undertake repair. In case of failure or refusal to comply with this mandate, PhilHealth shall undertake such repair works and shall be entitled to full reimbursement of expenses incurred therein upon demand.

Lot 1-Lenshold Improvement @ Room 1911

I. BASIC INFORMATION

Project Name	:	Lenshold Improvement of Room 1911 of CityState Building.
Location	:	19 th Floor, Room 1911, CityState Building 709 Shaw Blvd., Dugay, Oranbo, Pasig City
Duration	:	Twenty (20) calendar days
Approx. Floor Area	:	75 square meter

II. SCOPE OF WORKS

The Contractor shall coordinate with the Building Maintenance Unit of General Services and Bldg Maintenance Division (GSBMD/PRUD) immediately after receipt of Contract/Job Order to discuss the schedule of activities and methodology of the project.

The work to be done consists of furnishing all materials, tools, equipment and labor and performing all procedure necessary for the satisfactory completion of the project based on the technical drawing, material specification and this Technical Specifications:

1. Demolition/Removal of Drywall Partition
 - a. Remove existing drywall partition included all affected items such as door, jambs, electrical fixtures and its components such as electrical wires, utility boxes, switches, convenience outlets, wirings and conduits;
 - d. All demolished materials/debris to be disposed shall be presented to PhilHealth Building Maintenance Unit for inspection prior for its disposal outside the building premises.
 - e. Turn-over all reusable material/items to PhilHealth Building Maintenance Unit.
2. Restoration, Cleaning and Repainting of Ceiling Boards and Frames
 - a. Restore ceiling system affected by partition wall demolition;
 - b. Clean and paint ceiling boards (color white);
 - c. Re-paint exterior ceiling framing of at least two (2) coatings. Color shall be the same of the existing.
3. Supply and Installation of Laminated Flooring
 - a. Detach, alter and re-install all affected baseboards, doors, glass doors and jambs.
 - b. Furnish and install laminated flooring according to the approved specification including its necessary items for the complete completion of floor finishes such as but not limited to adhesives, foams, etc ;
 - c. Laminated flooring shall be tongue&groove laminated engineered wood with at least 8mm thickness, ± 190 mm width and ± 1900 mm in length.
Sample of laminated flooring shall be submitted to the End User thru GSBMD Representative for approval prior to installation.
4. Supply and Installation of Glass Wall Partition and Divider
 - b. Furnish and install wall-to-ceiling frosted glass wall partition and divider according to the approved drawing and specifications;
 - c. Install frosted stickers on main door;
5. Supply and Installation of Wall Paper
 - e. Prepare walls for the ready installation of wall paper: by patching/filling uneven wall surfaces;
 - f. Apply good quality wall paper on all interior concrete walls and drywalls.

Color swatches shall be submitted to the End User thru GSBMD Representative for approval prior to installation.

6. **Painting Works**

- a. Apply at least two (2) coatings of enamel paint on all interior wooden items such as ceiling cornices, baseboards, door and jambs.

Color swatches shall be submitted to the End User thru GSBMD Representative for approval prior to application.

7. **Electrical Works**

- a. Furnish and install convenience outlets as indicated in the electrical layout (*Annex A, Page 4 of 4*).
- b. Drill $\pm 1\frac{1}{2}"\text{Ø}$ holes into concrete slab and provide $-1\frac{1}{2}"\text{Ø}$ PVC conduit underneath slab for cables concealment (*Annex A, Page 4 of 4*).
- c. Provide boxes/conduit runners for cables to input and output holes;
- d. Re-wire all lighting fixtures from and convenience outlets affected during wall demolition;

III. PAYMENT

Payment shall be made within fifteen (15) working days upon completion of the following documentary requirement:

1. Perfected Contract/Job Order
2. Delivery Receipt/Sales Invoice/Billing Statement
3. Inspection Report
4. Certificate of Completion

IV. MISCELLANEOUS PROVISIONS

1. Other materials and/or works necessary to complete the project in acceptable and satisfactory manner which are not particularly specified herein shall be supplied, performed and finished by the Contractor/Supplier without additional cost to PhilHealth;
2. During workdays (Monday to Friday), all works shall be done only after every office hours which is 6:00PM until 5:00AM.
3. During weekends (Saturday and Sunday), there is no restricted time of works;
4. Cover/protect all existing properties in the area before commencement of actual improvement activities.
5. Clean-up project site after a day-to-day work activity. Construction debris shall be disposed to the location identified by PhilHealth Building Maintenance Unit;
6. Coordinate with PhilHealth Building Maintenance Unit at Room 1508, CityState Bldg., Tel./Fax. No.: 706-4811 for issuance of Working Permit/Gate Pass and for other related concerns;
7. The Contractor/Supplier shall assume full responsibility for the Works from the time project construction commenced up to final acceptance by PhilHealth and shall be held responsible for any damage or destruction of the Works except those occasioned by *force majeure*. The Contractor/Supplier shall be fully responsible for the safety, protection, security, and convenience of his personnel, third parties, and the public at large, as well as the Works, Equipment, installation, and the life to be affected by his construction work;
8. The Defects Liability Period shall be one (1) year from contract completion. The Certificate of Acceptance shall be issued by PhilHealth after all defects have been corrected. During this period, the Contractor shall undertake the repair works, at

his own expense, of any damage to the Works on account of the use of materials of inferior quality within seven (7) days from the time PhilHealth has issued an order to undertake repair. In case of failure or refusal to comply with this mandate, PhilHealth shall undertake such repair works and shall be entitled to full reimbursement of expenses incurred therein upon demand.

[Handwritten signature]

Section VII. Drawings

Lot 1-Leasehold Improvement @ Room 1603

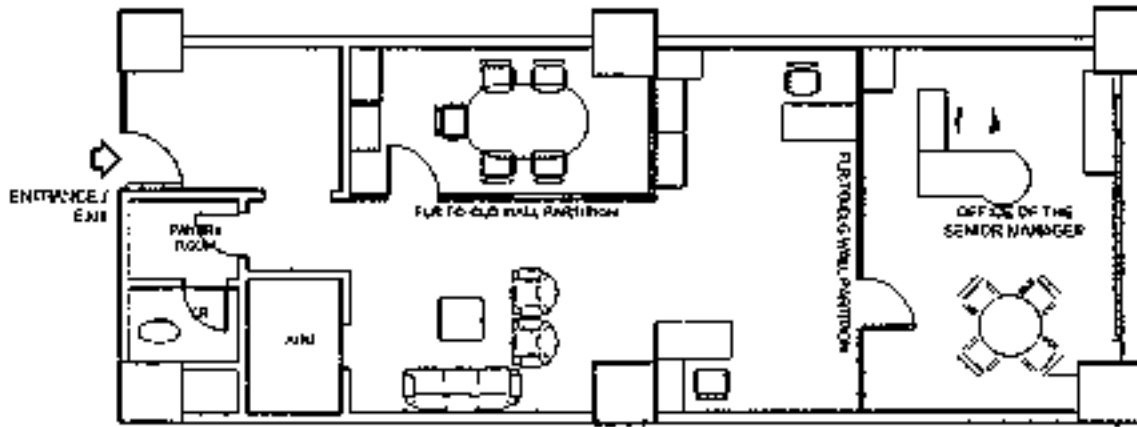

PROPOSED OFFICE LAYOUT
SCALE: 1/4" = 1'-0"

LEASEHOLD IMPROVEMENT @ ROOM 1603

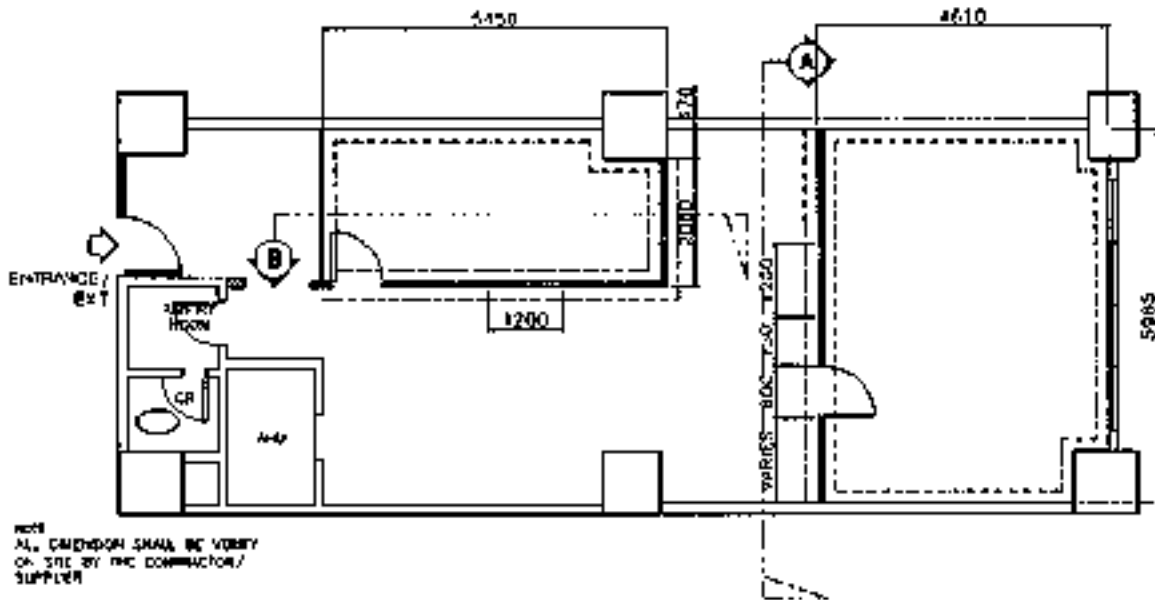

NOTE:
ALL DIMENSIONS SHALL BE VERIFY
ON-SITE BY THE CONTRACTOR/
SUPPLIER

LEGEND

- EXISTING WALL
- PROPOSED PARTITION
- NEW OPENING DIMENSION TO BE FINISHED
- CURB LEVEL TO BE AC-FINITE

PROPOSED PLAN
SCALE: 1/4" = 1'-0"

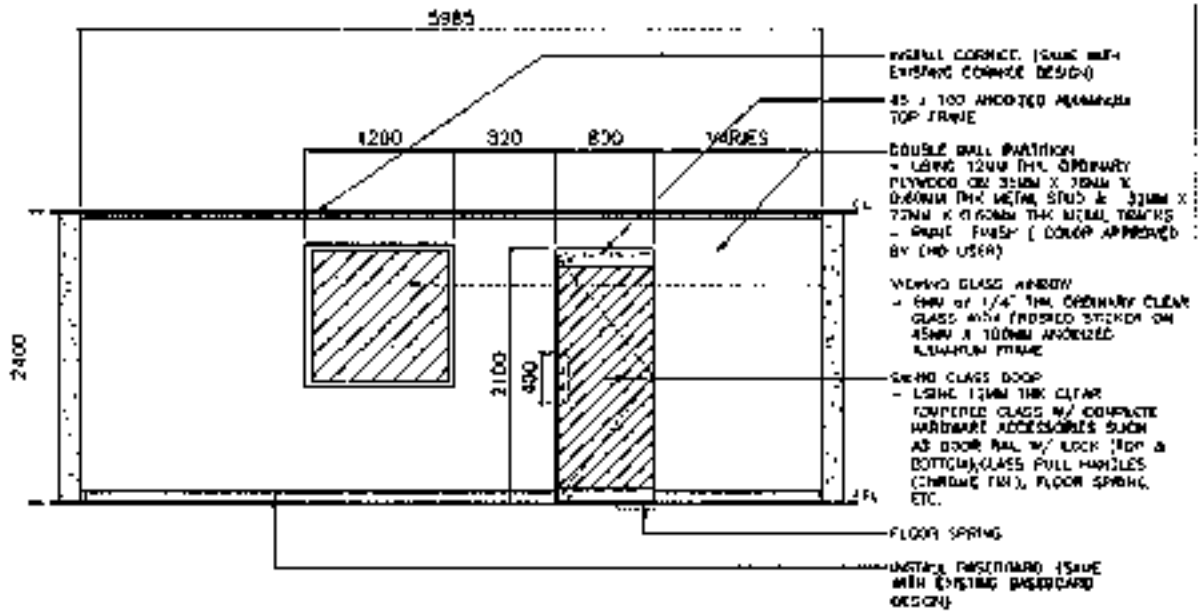

ELEVATION @ SECTION A
SCALE 1" = 3' 0"

ALL MATERIALS SHALL BE SPECIFIED BY THE ARCHITECT'S SUPPLIER

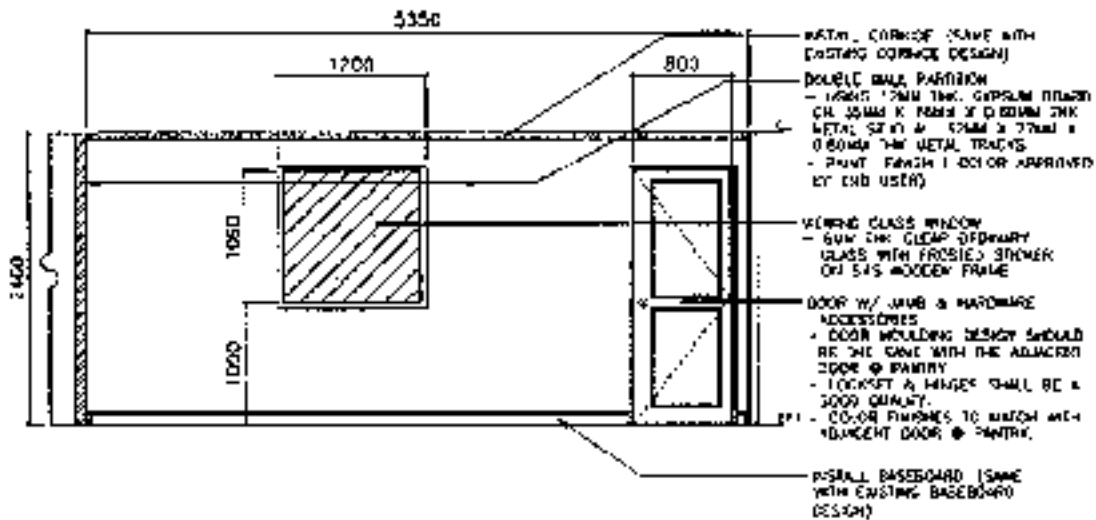



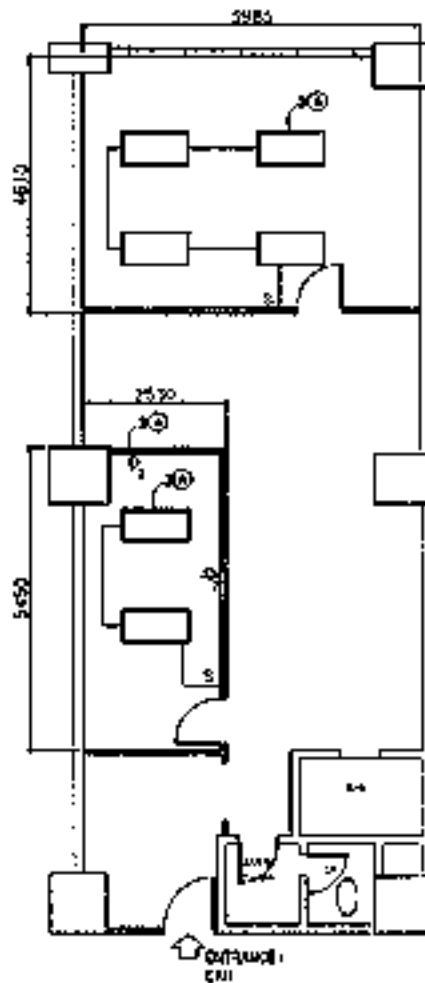

ELEVATION @ SECTION B
SCALE 1" = 3' 0"

ALL MATERIALS SHALL BE SPECIFIED BY THE ARCHITECT'S SUPPLIER



LEGEND

-  EXISTING LIGHTING FIXTURES TO BE RELOCATED
-  DUPLEX CONVENIENCE OUTLET
-  TAP TO EXISTING POWER
-  2-GANG SWITCH
-  RACEWAY CONDUIT CONCEALED IN CEILING

POWER & LIGHTING LAYOUT
SCALE N 13 1/4"

[Handwritten signatures and initials]

Lot 2-Leaschold Improvement @ Room 1906

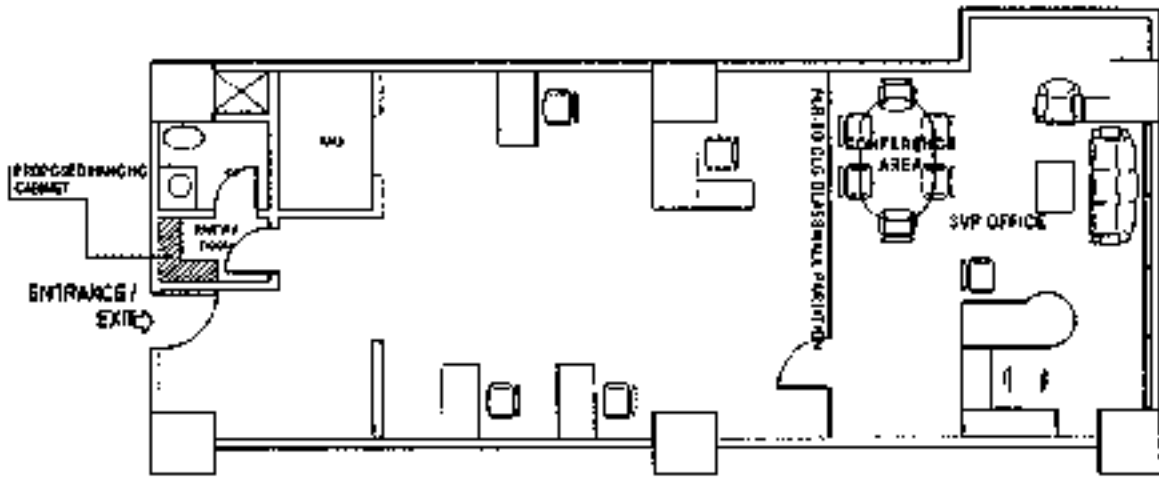

PROPOSED OFFICE LAYOUT
SCALE 1/4" = 1'-0"

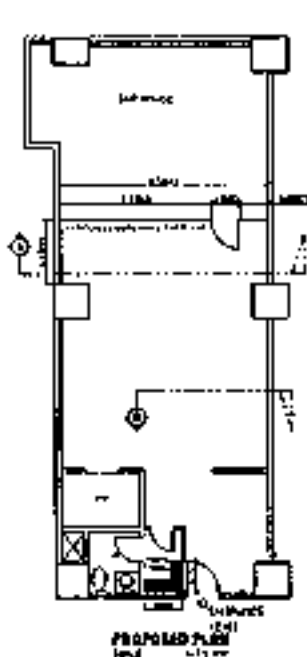

PROPOSED PLAN
SCALE 1/4" = 1'-0"

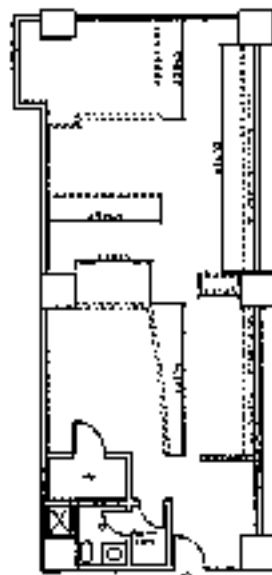

DETAILED PLAN
SCALE 1/4" = 1'-0"

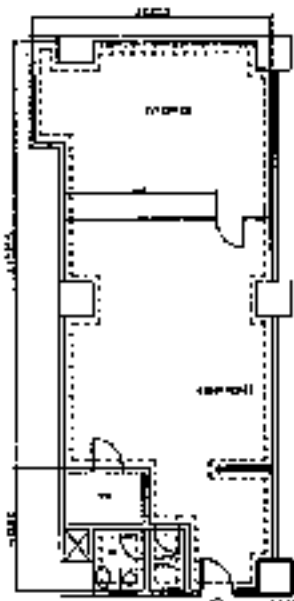

SCHEDULE OF PAINTING WORK
SCALE 1/4" = 1'-0"

- 1/4" = 1'-0" (width), 11'-0" (length), 11'-0" (width), 11'-0" (length), 11'-0" (width), 11'-0" (length)
- 1/4" = 1'-0" (width), 11'-0" (length), 11'-0" (width), 11'-0" (length), 11'-0" (width), 11'-0" (length)
- 1/4" = 1'-0" (width), 11'-0" (length), 11'-0" (width), 11'-0" (length), 11'-0" (width), 11'-0" (length)
- 1/4" = 1'-0" (width), 11'-0" (length), 11'-0" (width), 11'-0" (length), 11'-0" (width), 11'-0" (length)
- 1/4" = 1'-0" (width), 11'-0" (length), 11'-0" (width), 11'-0" (length), 11'-0" (width), 11'-0" (length)
- 1/4" = 1'-0" (width), 11'-0" (length), 11'-0" (width), 11'-0" (length), 11'-0" (width), 11'-0" (length)
- 1/4" = 1'-0" (width), 11'-0" (length), 11'-0" (width), 11'-0" (length), 11'-0" (width), 11'-0" (length)
- 1/4" = 1'-0" (width), 11'-0" (length), 11'-0" (width), 11'-0" (length), 11'-0" (width), 11'-0" (length)
- 1/4" = 1'-0" (width), 11'-0" (length), 11'-0" (width), 11'-0" (length), 11'-0" (width), 11'-0" (length)
- 1/4" = 1'-0" (width), 11'-0" (length), 11'-0" (width), 11'-0" (length), 11'-0" (width), 11'-0" (length)

PROPOSED WALL PARTITION @ ROOM 1906

[Handwritten signatures and initials]

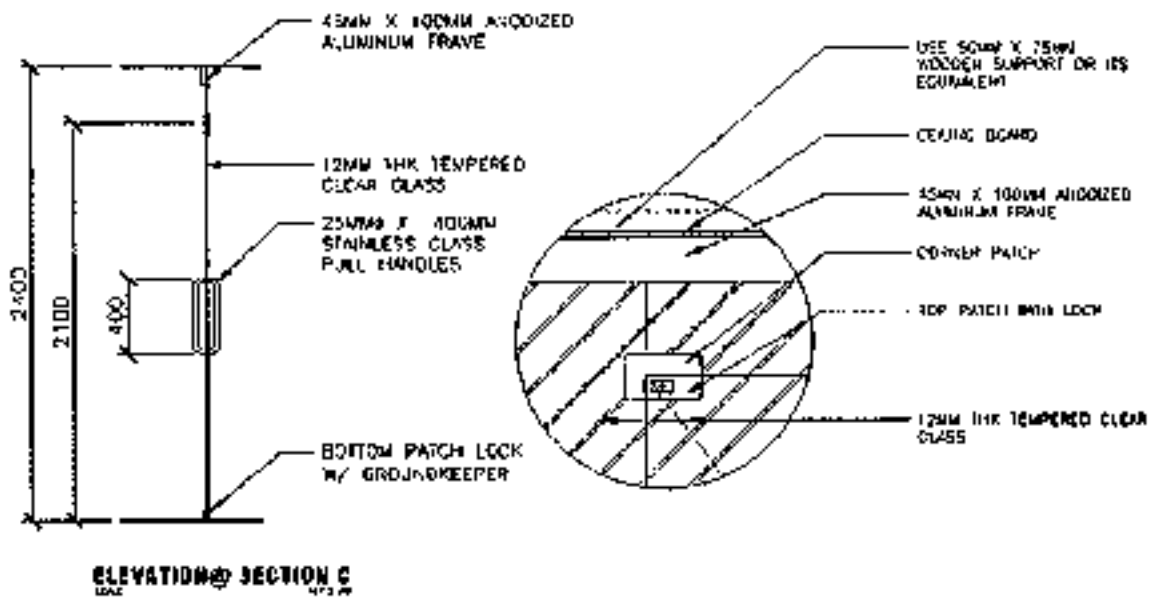
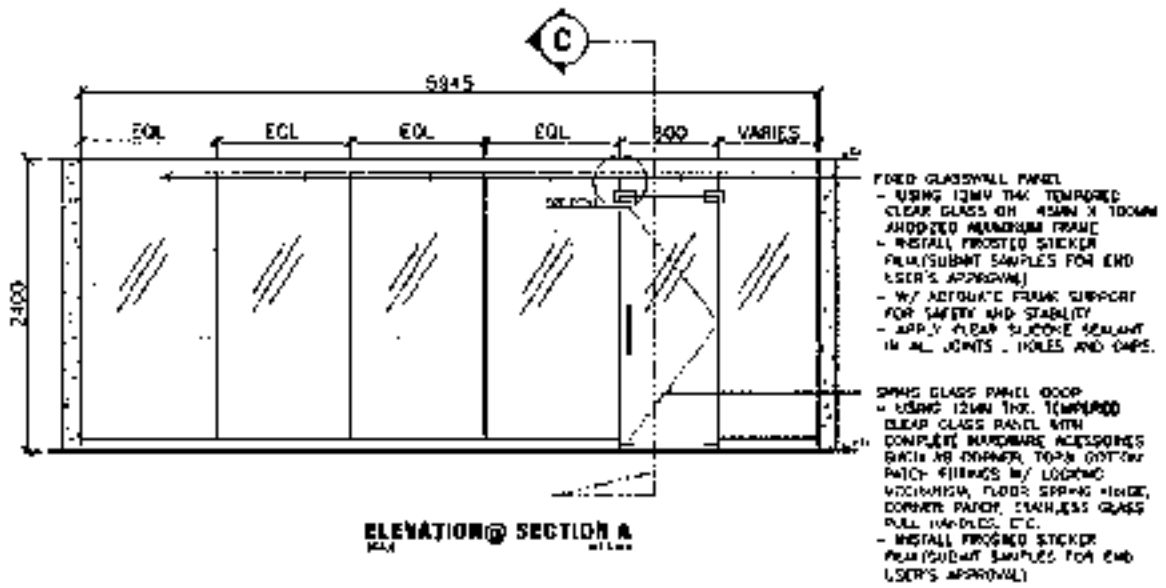

Handwritten signatures and initials:

g.

↑

h

x

pe

tw

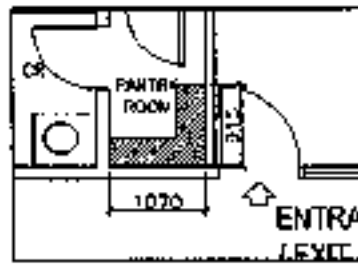

PLAN

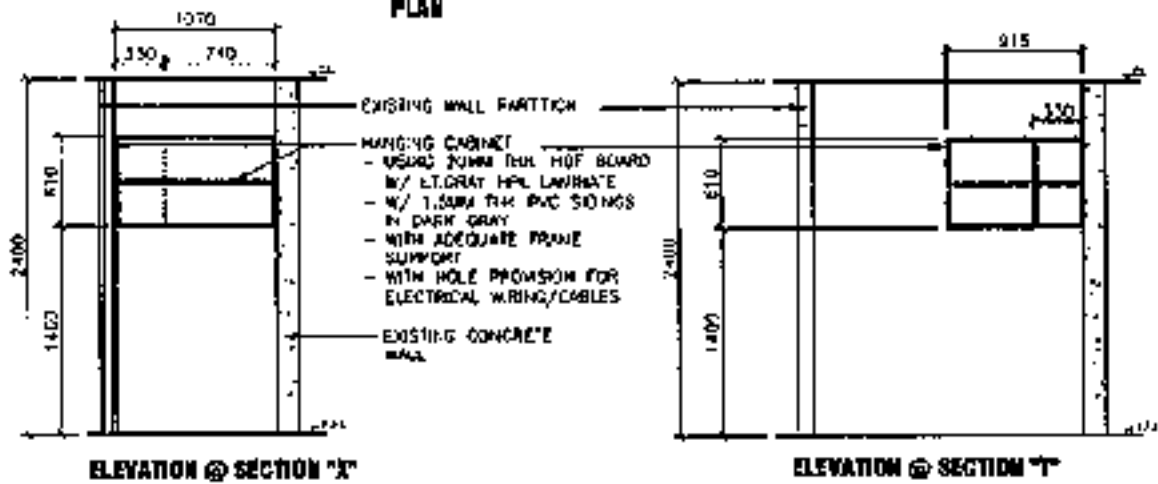

ELEVATION @ SECTION "X"

ELEVATION @ SECTION "Y"

PROPOSED HANGING CABINET @ PANTRY ROOM

Handwritten signatures and initials.

Lot 3-Leaschold Improvement @ Room 1911

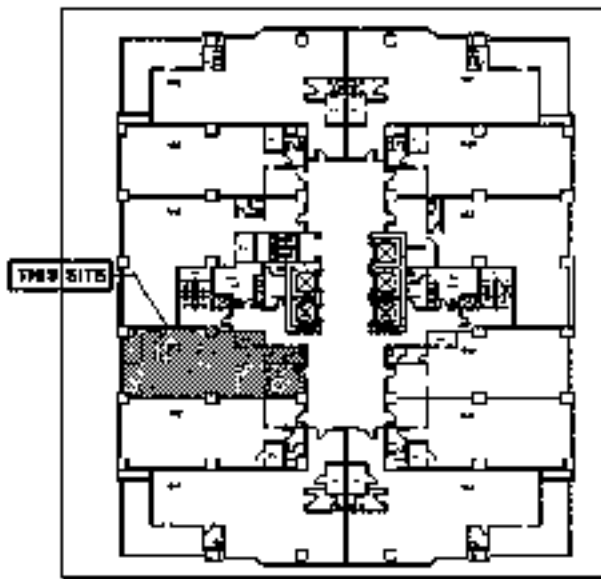

LOCATION PLAN

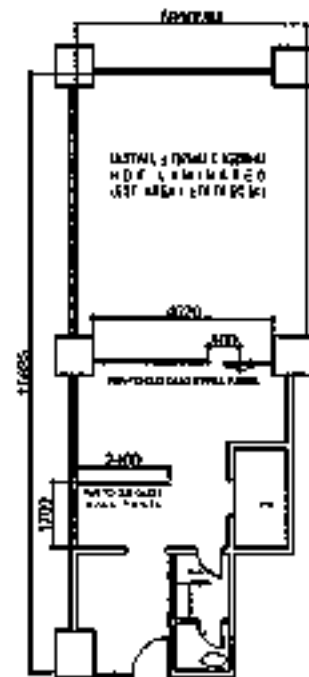

PLAN

WAR ROOM
LEASEHOLD IMPROVEMENT @ ROOM 1911
SCALE HTS

ANNEX "A"

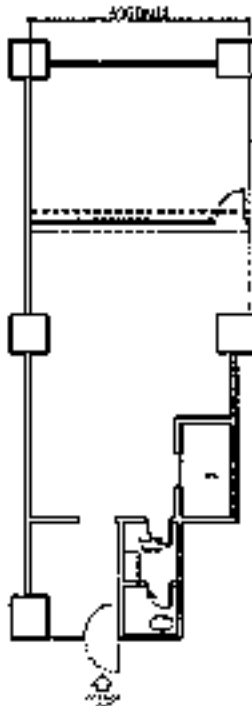

DEMOLITION PLAN

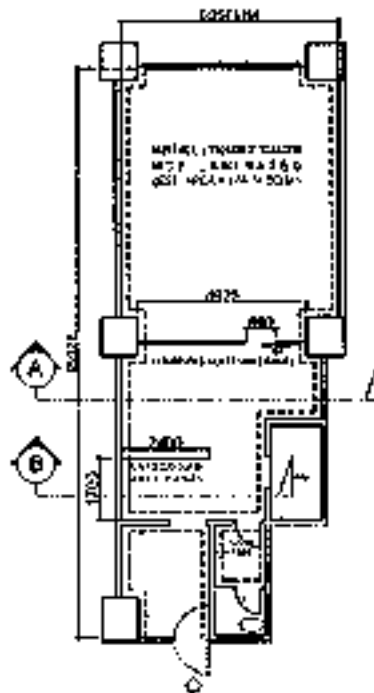

FLOOR PLAN

LEGEND:

- EXISTING CONCRETE WALL
- DOUBLE WALL PARTITION TO BE DEMOLISHED
- INSURANCE FOOT MARK

[Handwritten signatures and initials]

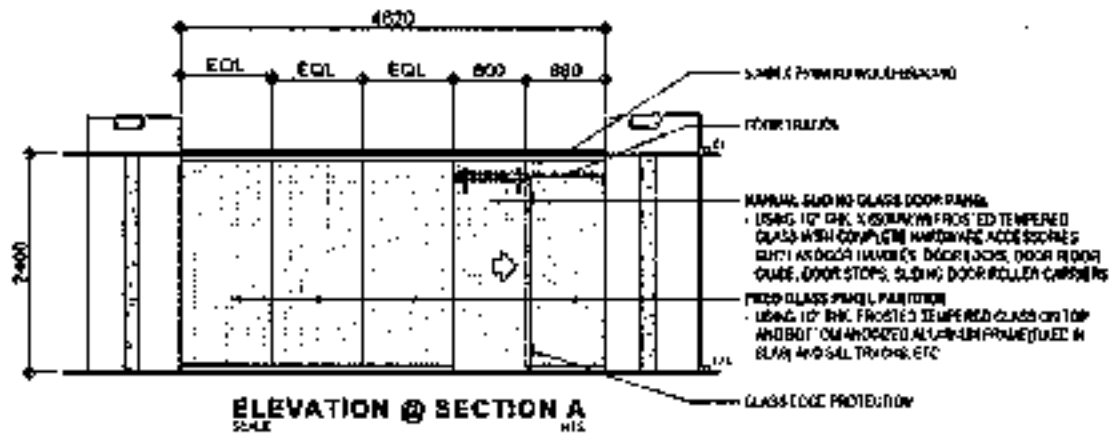

ELEVATION @ SECTION A
SCALE

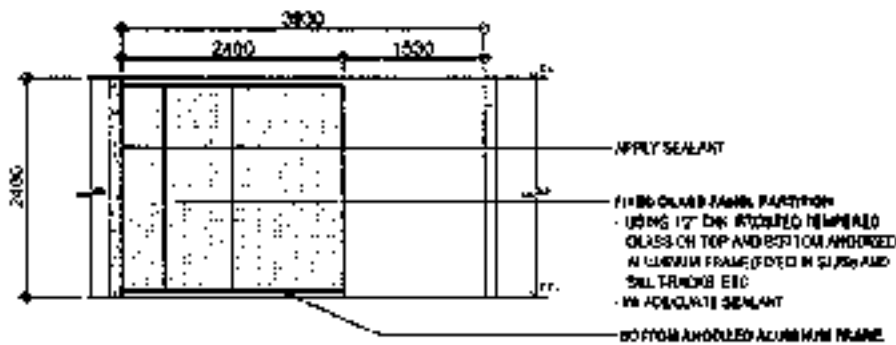

ELEVATION @ SECTION B
SCALE

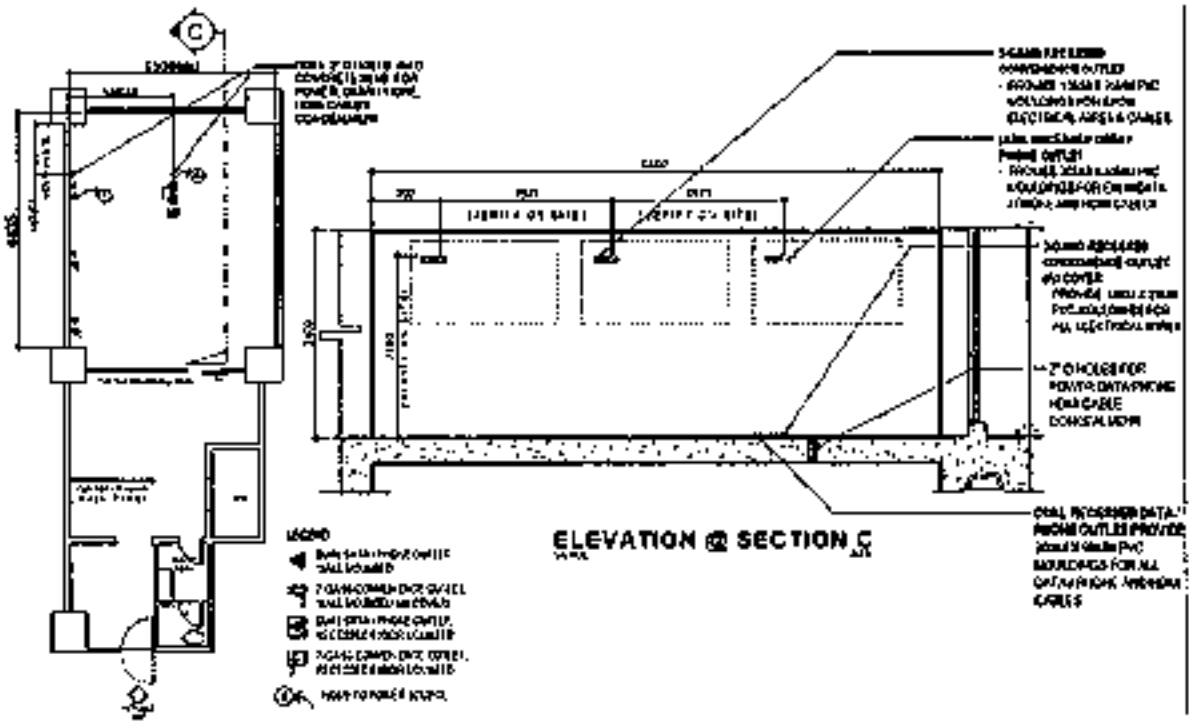

ELEVATION @ SECTION C
SCALE

POWER & DATA/PHONE LAYOUT
SCALE

[Handwritten signatures and initials]

Section VIII. Bill of Quantities

Notes on the Bill of Quantities

Objectives

The objectives of the Bill of Quantities are:

- (a) to provide sufficient information on the quantities of Works to be performed to enable Bids to be prepared efficiently and accurately; and
- (b) when a Contract has been entered into, to provide a priced Bill of Quantities for use in the periodic valuation of Works executed.

In order to attain these objectives, Works should be itemized in the Bill of Quantities in sufficient detail to distinguish between the different classes of Works, or between Works of the same nature carried out in different locations or in other circumstances which may give rise to different considerations of cost. Consistent with these requirements, the layout and content of the Bill of Quantities should be as simple and brief as possible.

Daywork Schedule

A Daywork Schedule should be included only if the probability of unforeseen work, outside the items included in the Bill of Quantities, is high. To facilitate checking by the Entity of the realism of rates quoted by the Bidders, the Daywork Schedule should normally comprise the following:

- (a) A list of the various classes of labor, materials, and Constructional Plant for which basic daywork rates or prices are to be inserted by the Bidder, together with a statement of the conditions under which the Contractor will be paid for work executed on a daywork basis.
- (b) Nominal quantities for each item of Daywork, to be priced by each Bidder at Daywork rates as Bid. The rate to be entered by the Bidder against each basic Daywork item should include the Contractor's profit, overheads, supervision, and other charges.

Provisional Sums

A general provision for physical contingencies (quantity overruns) may be made by including a provisional sum in the Summary Bill of Quantities. Similarly, a contingency allowance for possible price increases should be provided as a provisional sum in the Summary Bill of Quantities. The inclusion of such provisional sums often facilitates budgetary approval by avoiding the need to request periodic supplementary approvals as the future need arises. Where such provisional sums or contingency allowances are used, the SCC should state the manner in which they will be used, and under whose authority (usually the Procuring Entity's Representative's).

The estimated cost of specialized work to be carried out, or of special goods to be supplied, by other contractors (refer to GCC Clause 8) should be indicated in the relevant part of the Bill of Quantities as a particular provisional sum with an appropriate brief description. A separate procurement procedure is normally carried out by the Procuring Entity to select such specialized contractors. To provide an element of competition among the Bidders in respect of any facilities, amenities, attendance, etc., to be provided by the successful

Bidder as prime Contractor for the use and convenience of the specialist contractors, each related provisional sum should be followed by an Item in the Bill of Quantities inviting the Bidder to quote a sum for such amenities, facilities, attendance, etc.

Signature Box

A signature box shall be added at the bottom of each page of the Bill of Quantities where the authorized representative of the Bidder shall affix his signature. Failure of the authorized representative to sign each and every page of the Bill of Quantities shall be a cause for rejection of his bid.

These Notes for Preparing a Bill of Quantities are intended only as information for the Procuring Entity or the person drafting the Bidding Documents. They should not be included in the final documents.

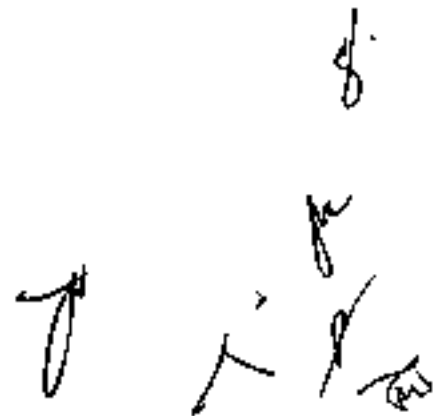
Handwritten signatures and initials in the bottom right corner of the page. There are several distinct marks, including what appears to be a large stylized 'J' or 'I', and other scribbled-out characters.

Bid Form

Date: _____
BIN¹: _____

To: **Philippine Health Insurance Corporation**
Address: **709 citystate center, shaw blvd. brgy. Orunbo, Pasig City**

We, the undersigned, declare that:

- (a) We have examined and have no reservation to the Bidding Documents, including Addenda, for the Contract Procurement of Three (3) Lots Leasehold Improvements;
- (b) We offer to execute the Works for this Contract in accordance with the Bid and Bid Data Sheet, General and Special Conditions of Contract accompanying this Bid;
The total price of our Bid, excluding any discounts offered below is: [insert information];
The discounts offered and the methodology for their application are: [insert information];
- (c) Our Bid shall be valid for a period of [insert number] days from the date fixed for the Bid submission deadline in accordance with the Bidding Documents, and it shall remain binding upon us and may be accepted at any time before the expiration of that period;
- (d) If our Bid is accepted, we commit to obtain a Performance Security in the amount of [insert percentage amount] percent of the Contract Price for the due performance of the Contract;
- (e) Our firm, including any subcontractors or suppliers for any part of the Contract, have nationalities from the following eligible countries: ;
- (f) We are not participating, as Bidders, in more than one Bid in this bidding process, other than alternative offers in accordance with the Bidding Documents;
- (g) Our firm, its affiliates or subsidiaries, including any subcontractors or suppliers for any part of the Contract, has not been declared ineligible by the Funding Source.
- (h) We understand that this Bid, together with your written acceptance thereof included in your notification of award, shall constitute a binding contract between us, until a formal Contract is prepared and executed; and
- (i) We understand that you are not bound to accept the Lowest Calculated Bid or any other Bid that you may receive.
- (j) We likewise certify/confirm that the undersigned, is the duly authorized representative of the bidder, and granted full power and authority to do, execute and perform any and all acts necessary to participate, submit the bid, and to sign and execute the ensuing contract for the Procurement of Three (3) Lots Leasehold Improvements of the Philippine Health Insurance Corporation.
- (k) We acknowledge that failure to sign each and every page of this Bid Form, including the Bill of Quantities, shall be a ground for the rejection of our bid.

Name: _____
In the capacity of: _____
Signed: _____
Duly authorized to sign the Bid for and on behalf of: _____
Date: _____

¹ If ADB, JICA and WB funded projects, use IFR.

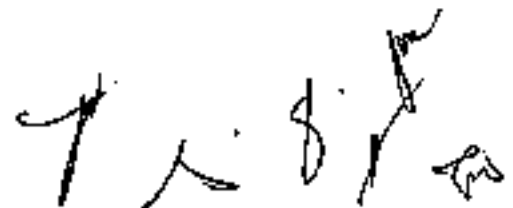

Form of Contract Agreement

THIS AGREEMENT, made this _____ day of _____, between *Philippine Health Insurance Corporation of the Philippines* (hereinafter called the "Entity") and *[name and address of Contractor]* (hereinafter called the "Contractor").

WHEREAS, the Entity is desirous that the Contractor execute *Procurement of Three (3) Lots Leasehold Improvements ITB No. LI 2018-01-Infra* (hereinafter called "the Works") and the Entity has accepted the Bid for *[insert the amount in specified currency in numbers and words]* by the Contractor for the execution and completion of such Works and the remedying of any defects therein.

NOW THIS AGREEMENT WITNESSETH AS FOLLOWS:

1. In this Agreement, words and expressions shall have the same meanings as are respectively assigned to them in the Conditions of Contract hereinafter referred to.
2. The following documents shall be attached, deemed to form, and be read and construed as integral part of this Agreement, to wit:
 - (a) General and Special Conditions of Contract;
 - (b) Drawings/Plans;
 - (c) Specifications;
 - (d) Invitation to Bid;
 - (e) Instructions to Bidders;
 - (f) Bid Data Sheet;
 - (g) Addenda and/or Supplemental/Bid Bulletins, if any;
 - (h) Bid form, including all the documents/statements contained in the Bidder's bidding envelopes, as annexes, and all other documents submitted (e.g., Bidder's response to request for clarifications on the bid), including corrections to the bid, if any, resulting from the Procuring Entity's bid evaluation;
 - (i) Eligibility requirements, documents and/or statements;
 - (j) Performance Security;
 - (k) Notice of Award of Contract and the Bidder's conforme thereto;
 - (l) Other contract documents that may be required by existing laws and/or the Entity.
3. In consideration of the payments to be made by the Entity to the Contractor as hereinafter mentioned, the Contractor hereby covenants with the Entity to execute and complete the Works and remedy any defects therein in conformity with the provisions of this Contract in all respects.
4. The Entity hereby covenants to pay the Contractor in consideration of the execution and completion of the Works and the remedying of defects wherein, the Contract Price or such other sum as may become payable under the provisions of this Contract at the times and in the manner prescribed by this Contract.

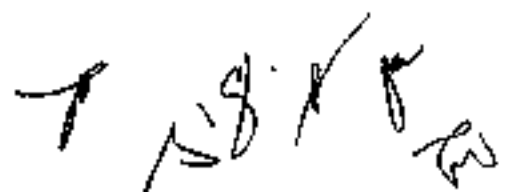

IN WITNESS whereof the parties thereto have caused this Agreement to be executed the day and year first before written.

Signed, sealed, delivered by _____ the _____ (for the Entity)

Signed, sealed, delivered by _____ the _____ (for the Contractor).

Binding Signature of Procuring Entity

Binding Signature of Contractor

[Addendum showing the corrections, if any, made during the Bid evaluation should be attached with this agreement]

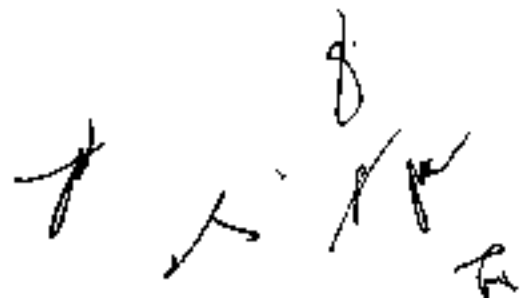
Handwritten signatures and initials in black ink, including a large signature on the left, a smaller one in the middle, and several initials on the right.

Omnibus Sworn Statement

REPUBLIC OF THE PHILIPPINES)
CITY/MUNICIPALITY OF _____) S S

AFFIDAVIT

I, *[Name of Affiant]*, of legal age, *[Civil Status]*, *[Nationality]*, and residing at *[Address of Affiant]*, after having been duly sworn in accordance with law, do hereby depose and state that:

1. *Select one, delete the other:*

If a sole proprietorship: I am the sole proprietor or authorized representative of *[Name of Bidder]* with office address at *[address of Bidder]*;

If a partnership, corporation, cooperative, or joint venture: I am the duly authorized and designated representative of *[Name of Bidder]* with office address at *[address of Bidder]*;

2. *Select one, delete the other:*

If a sole proprietorship: As the owner and sole proprietor or authorized representative of *[Name of Bidder]*, I have full power and authority to do, execute and perform any and all acts necessary to participate, submit the bid, and to sign and execute the ensuing contract for **Procurement of Three (3) Lots Leasehold Improvement of the Philippine Health Insurance Corporation.**

If a partnership, corporation, cooperative, or joint venture: I am granted full power and authority to do, execute and perform any and all acts necessary to participate, submit the bid, and to sign and execute the ensuing contract for **Procurement of Three (3) Lots Leasehold Improvement of the Philippine Health Insurance Corporation,** accompanied by the duly notarized Special Power of Attorney, Board/Partnership Resolution, or Secretary's Certificate, whichever is applicable;

3. *[Name of Bidder]* is not "blacklisted" or barred from bidding by the Government of the Philippines or any of its agencies, offices, corporations, or Local Government Units, foreign government/foreign or international financing institution whose blacklisting rules have been recognized by the Government Procurement Policy Board;
4. Each of the documents submitted in satisfaction of the bidding requirements is an authentic copy of the original, complete, and all statements and information provided therein are true and correct;
5. *[Name of Bidder]* is authorizing the Head of the Procuring Entity or its duly authorized representative(s) to verify all the documents submitted;

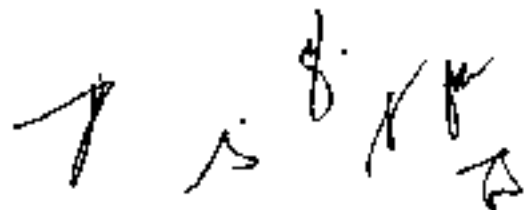

6. **Select one, delete the rest:**

If a sole proprietorship: The owner or sole proprietor is not related to the Head of the Procuring Entity, members of the Bids and Awards Committee (BAC), the Technical Working Group, and the BAC Secretariat, the head of the Project Management Office or the end-user unit, and the project consultants by consanguinity or affinity up to the third civil degree;

If a partnership or cooperative: None of the officers and members of [Name of Bidder] is related to the Head of the Procuring Entity, members of the Bids and Awards Committee (BAC), the Technical Working Group, and the BAC Secretariat, the head of the Project Management Office or the end-user unit, and the project consultants by consanguinity or affinity up to the third civil degree;

If a corporation or joint venture: None of the officers, directors, and controlling stockholders of [Name of Bidder] is related to the Head of the Procuring Entity, members of the Bids and Awards Committee (BAC), the Technical Working Group, and the BAC Secretariat, the head of the Project Management Office or the end-user unit, and the project consultants by consanguinity or affinity up to the third civil degree;

7. [Name of Bidder] complies with existing labor laws and standards; and
8. [Name of Bidder] is aware of and has undertaken the following responsibilities as a Bidder:
- a) Carefully examine all of the Bidding Documents;
 - b) Acknowledge all conditions, local or otherwise, affecting the implementation of the Contract;
 - c) Made an estimate of the facilities available and needed for the contract to be bid, if any; and
 - d) Inquire or secure Supplemental/Bid Bulletin(s) issued for the *Procurement of Three (3) Lots Leasehold Improvement.*
9. [Name of Bidder] did not give or pay directly or indirectly, any commission, amount, fee, or any form of consideration, pecuniary or otherwise, to any person or official, personnel or representative of the government in relation to any procurement project or activity.

IN WITNESS WHEREOF, I have hereunto set my hand this ___ day of ___, 20__ at _____, Philippines.

Bidder's Representative/Authorized Signatory

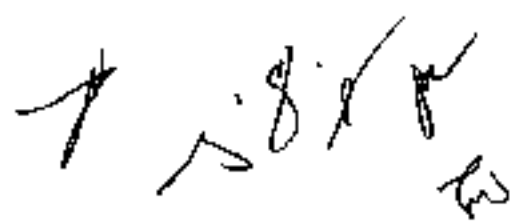
Handwritten signature and initials in black ink, appearing to be 'R. G. R.' with a small 'TW' below it.

SUBSCRIBED AND SWORN to before me this ___ day of [month] [year] at [place of execution], Philippines. Affiant/s is/are personally known to me and was/were identified by me through competent evidence of identity as defined in the 2004 Rules on Notarial Practice (A.M. No. 02-8-13-SC). Affiant/s exhibited to me his/her [insert type of government identification card used], with his/her photograph and signature appearing thereon, with no. _____ and his/her Community Tax Certificate No. _____ issued on _____ at _____.

Witness my hand and seal this ___ day of [month] [year].

NAME OF NOTARY PUBLIC

Serial No. of Commission _____

Notary Public for _____ until _____

Roll of Attorneys No. _____

PTR No. _____ [date issued], [place issued]

IBP No. _____ [date issued], [place issued]

Doc. No. _____

Page No. _____

Book No. _____

Series of _____

* This form will not apply for WB funded projects.



Bid-Securing Declaration

(REPUBLIC OF THE PHILIPPINES)
CITY OF _____) S.S.

-----x

Invitation to Bid *[Insert reference number]*

To: *[Insert name and address of the Procuring Entity]*

I/We, the undersigned, declare that:

1. I/We understand that, according to your conditions, bids must be supported by a Bid Security, which may be in the form of a Bid-Securing Declaration.
2. I/We accept that: (a) I/we will be automatically disqualified from bidding for any contract with any procuring entity for a period of two (2) years upon receipt of your Blacklisting Order; and, (b) I/we will pay the applicable fine provided under Section 6 of the Guidelines on the Use of Bid Securing Declaration, within fifteen (15) days from receipt of written demand by the procuring entity for the commission of acts resulting to the enforcement of the bid securing declaration under Sections 23.1(b), 34.2, 40.1 and 69.1, except 69.1 (f), of the IRR of RA 9184; without prejudice to other legal action the government may undertake.
3. I/We understand that this Bid-Securing Declaration shall cease to be valid on the following circumstances:
 - a. Upon expiration of the bid validity period, or any extension thereof pursuant to your request;
 - b. I am/we are declared ineligible or post-disqualified upon receipt of your notice to such effect, and (i) I/we failed to timely file a request for reconsideration or (ii) I/we filed a waiver to avail of said right;
 - c. I am/we are declared as the bidder with the Lowest Calculated Responsive Bid, and I/we have furnished the performance security and signed the Contract.



IN WITNESS WHEREOF, I/We have hereunto set my/our hand/s this ____ day of *[month]* *[year]* at *[place of execution]*.

[Insert NAME OF BIDDER'S AUTHORIZED REPRESENTATIVE]
[Insert signatory's legal capacity]

Affiant

SUBSCRIBED AND SWORN to before me this ___ day of *[month]* *[year]* at *[place of execution]*, Philippines. Affiant/s is/are personally known to me and was/were identified by me through competent evidence of identity as defined in the 2004 Rules on Notarial Practice (A.M. No. 02-8-13-SC). Affiant/s exhibited to me his/her *[insert type of government identification card used]*, with his/her photograph and signature appearing thereon, with no. _____.

Witness my hand and seal this ___ day of *[month]* *[year]*.

NAME OF NOTARY PUBLIC

Serial No. of Commission _____

Notary Public for _____ until _____

Roll of Attorneys No. _____

PTR No. __, *[date issued]*, *[place issued]*

IDP No. __, *[date issued]*, *[place issued]*

Doc. No. _____

Page No. _____

Book No. _____

Series of _____.